

Hose and Flexible Tubing

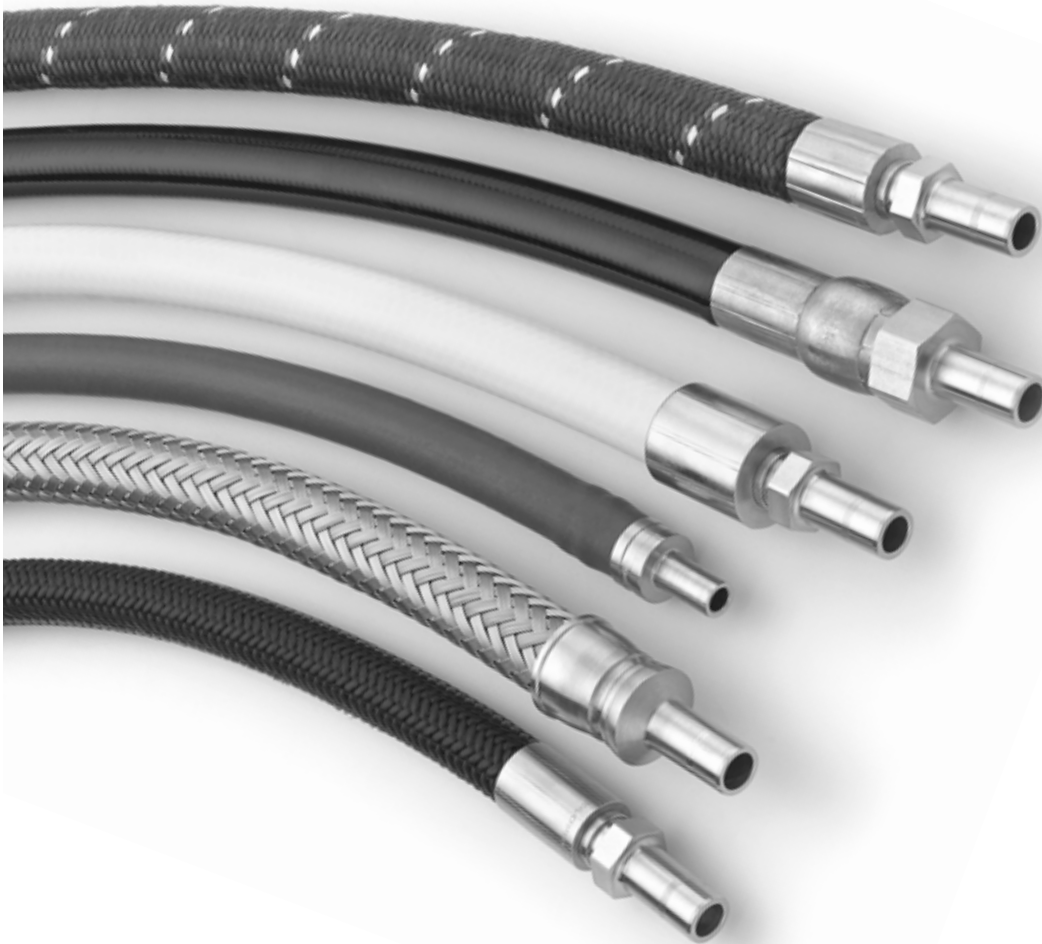

Hose Assemblies, Bulk Hose, Flexible Tubing, and End Connections

- Core materials include metal, PTFE, PFA, vinyl, nylon, polyethylene, and rubber
- Nominal hose sizes 1/8 to 2 in.
- Wide range of fractional and metric end connections
- Custom lengths available
- Optional covers, tagging, and testing

Contents

Swagelok® Hose and Flexible Tubing Nomenclature, 4

Swagelok Hose and Flexible Tubing Selection Guide, 7

Considerations for Selecting a Hose Assembly Solution, 9

Swagelok Hose and Flexible Tubing Installation and Use Guide, 10

Metal Hose

FX Series Metal Hose, 11



FM Series Metal Hose, 16



FJ Series Metal Hose, 22



FL Series Metal Hose, 27



AH Series Metal Hose, 33



FV Series Vacuum-Insulated Metal Hose, 37

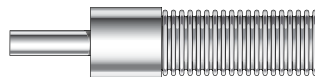

Metal Flexible Tubing

FN Metal Tubing, 40

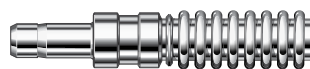

FZ Metal Tubing, 42



Hybrid Hose

FP Series Hybrid Hose, 46

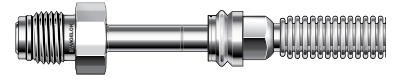

Fluoropolymer Hose

T Series PTFE Hose, 49



B Series PTFE Hose, 55



X Series PTFE Hose, 57



S Series PTFE Hose, 59



C Series PTFE Hose, 61



J Series PTFE Hose, 63



Contents

N Series PTFE Hose, 65



W Series PTFE Hose, 67



F Series PTFE Hose, 69



U Series PFA Hose, 71



PFA Tubing

PFA Series PFA Tubing, 83



Vinyl Tubing

LT Series Vinyl Tubing, 85



Hose Connectors

HC Series—End Connections for Soft Tubing and Hose, 86

Nylon Hose

NG Series Nylon Hose, 89



7R and 8R Series Nylon Hose, 94



7N Series Nylon Hose, 95



Polyethylene Hose

7P Series Polyethylene Hose, 100



Rubber Hose

PB Series Rubber Hose, 102



Options

Covers, 107



Testing, 108

Tags, 109



Approvals, 110

Considerations for Hose Insulation, 112

Y Insulation Option, 113

Tools and Accessories

Cutting Tools for Hose and Soft Tubing, 114



Assembly Tools for Nylon, Polyethylene, and Rubber Hose, 114

Dimensions, in inches (millimeters), are for reference only and are subject to change. Dimensions are shown with Swagelok nuts finger-tight. For Swagelok nut dimensions, refer to *Gaugeable Tube Fittings and Adapter Fittings* catalog, [MS-01-140](#). For technical drawings showing dimensions, contact your authorized Swagelok sales and service representative.

Swagelok Hose and Flexible Tubing Nomenclature

Hose

A multiple-layered flexible conduit through which fluid is conveyed from one point to another.

Nominal Hose Size

An approximation of the hose inside diameter.

Flexible Tubing

A single-layered flexible conduit through which fluid is conveyed from one point to another.

Bend Radius

The radius of the bent section of hose, measured to the center line or inside of the curved section.

Minimum Dynamic Bend Radius

The smallest bend radius that a hose is rated to perform in a dynamic application.

Minimum Static Bend Radius

The smallest bend radius that a hose is rated to perform in a static application.

Flexibility

The relative ease or difficulty of bending a nonpressurized hose or tubing assembly.

Burst Pressure

The pressure at which leakage occurs when exposed to a laboratory burst test.

Permeation

The movement of a liquid, gas, or vapor through a solid. All materials are permeable to a degree and should be tested for application compatibility prior to installation.

Dynamic Application

An application in which the hose flexes or changes position.

Static Application

An application in which the hose is stationary and does not move in any plane.

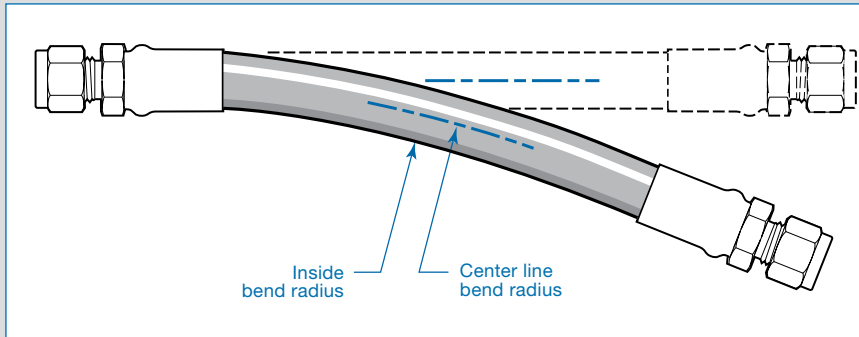

Splices

Splices consist of a connector fitting and crimp collars that join two lengths of hose to form assemblies. Splices may be required to obtain longer hose lengths of fluoropolymer hose (B, X, S, C, J, N, W, F, and U series), as noted in the **Ordering Information** for each series.

Splice dimensions shown in the table at right are for reference only and are subject to change. Additional overall hose length may be needed to compensate for the effect of splices on hose minimum bend radius. For more information, contact your authorized Swagelok sales and service representative.

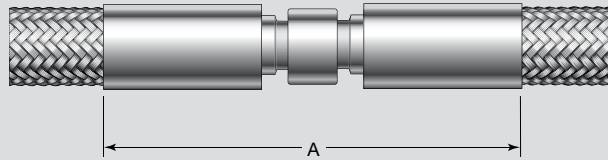

Nominal Hose Size in. (mm)	Dimensions, in. (mm)		
	A Maximum	Minimum Inside Diameter	Maximum Outside Dimension
1/8 (3.2)	2.60 (66.0)	0.070 (1.7)	0.55 (14.0)
1/4 (6.4)	2.60 (66.0)	0.16 (4.0)	0.59 (15.0)
3/8 (9.6)	3.30 (83.8)	0.26 (6.6)	0.82 (20.8)
1/2 (12.7)	3.70 (94.0)	0.34 (8.6)	1.04 (26.4)
3/4 (19.0)	4.80 (122)	0.54 (13.7)	1.35 (34.3)
1 (25.4)	4.60 (117)	0.78 (19.8)	1.75 (44.4)
1 1/2 (38.1)	5.60 (142)	1.24 (31.4)	2.20 (55.9)
2 (50.8)	6.90 (175)	1.68 (42.6)	2.74 (69.6)

Swagelok Hose and Flexible Tubing Nomenclature

Conductive

A material that easily conducts an electrical current, having an electrical resistance less than 1×10^4 ohms. Swagelok hoses with metal cores are examples of conductive hoses.

Static Dissipative

A material that has the ability to alleviate a static electrical charge, having an electrical resistance more than 1×10^4 ohms but less than 1×10^{11} ohms. Select Swagelok hoses are constructed with carbon black filled core materials (nylon, PTFE, or PFA) to provide static dissipation. The intent of a hose being static dissipative is to alleviate any static charge that may build as fluid flows through the hose. Note that hoses with conductive cores may also be used in applications where fluid flow generates a static charge. The lower electrical resistance in a conductive core dissipates the charge more readily.

Non-Conductive

A material that does not normally transmit or conduct an electrical charge. Materials considered non-conductive have an electrical resistance in excess of 1×10^{11} ohms. Swagelok hoses constructed with non-metallic cores that do not contain carbon black are generally non-conductive. However, the presence of metal braid may make a hose conductive from end connection to end connection.

Unspecified

The term used for hoses that do not have a design intent concerning electrical properties. These hoses may be either conductive or non-conductive depending on assembly tolerances from hose to hose, or other factors.

It is important to consider the electrical properties of the hose core, the reinforcing layer(s), and the overall end-to-end assembly to ensure the desired results. A hose is considered conductive if it easily carries a charge from one end connection to the other, even if the core does not contain carbon black. The charge is carried through the metal reinforcing braid. If the core does not contain carbon black, the media in the hose is electrically insulated from the wire braid, making it possible for a charge to build along the core tube.

The table below summarizes the electrical properties of each hose series core, reinforcement layer(s), and total assembly end-to-end. Hoses are identified with a letter notation as follows:

- Non-conductive (N)
- Conductive (C)
- Static dissipative (D)
- Unspecified (U)
- Not applicable (N/A)

Hose Series	Core	Reinforcement	End Connection to End Connection
FM	C	C	C
FJ	C	C	C
FL	C	C	C
FX	C	C	C
AH	C	C	C
FV	C	C	C
FN	C	N/A	C
FZ	C	N/A	C
TH	N	C	C
TC	D	C	C
TL	N	C	C
BT	N	U	U
XT	N	U	U
XC	D	U	D
ST	N	U	U

Hose Series	Core	Reinforcement	End Connection to End Connection
SC	D	U	D
CT	N	U	U
CC	D	U	D
JT	N	U	U
NC	D	U	D
WC	D	U	D
FT	N	U	U
FC	D	U	D
UT	N	U	U
UC	D	U	D
NG	D	U	D
7R	N	U	U
8R	N	U	U
7N	N	N	N
7P	N	U	U
PB	N	U	U

Swagelok Hose and Flexible Tubing Nomenclature

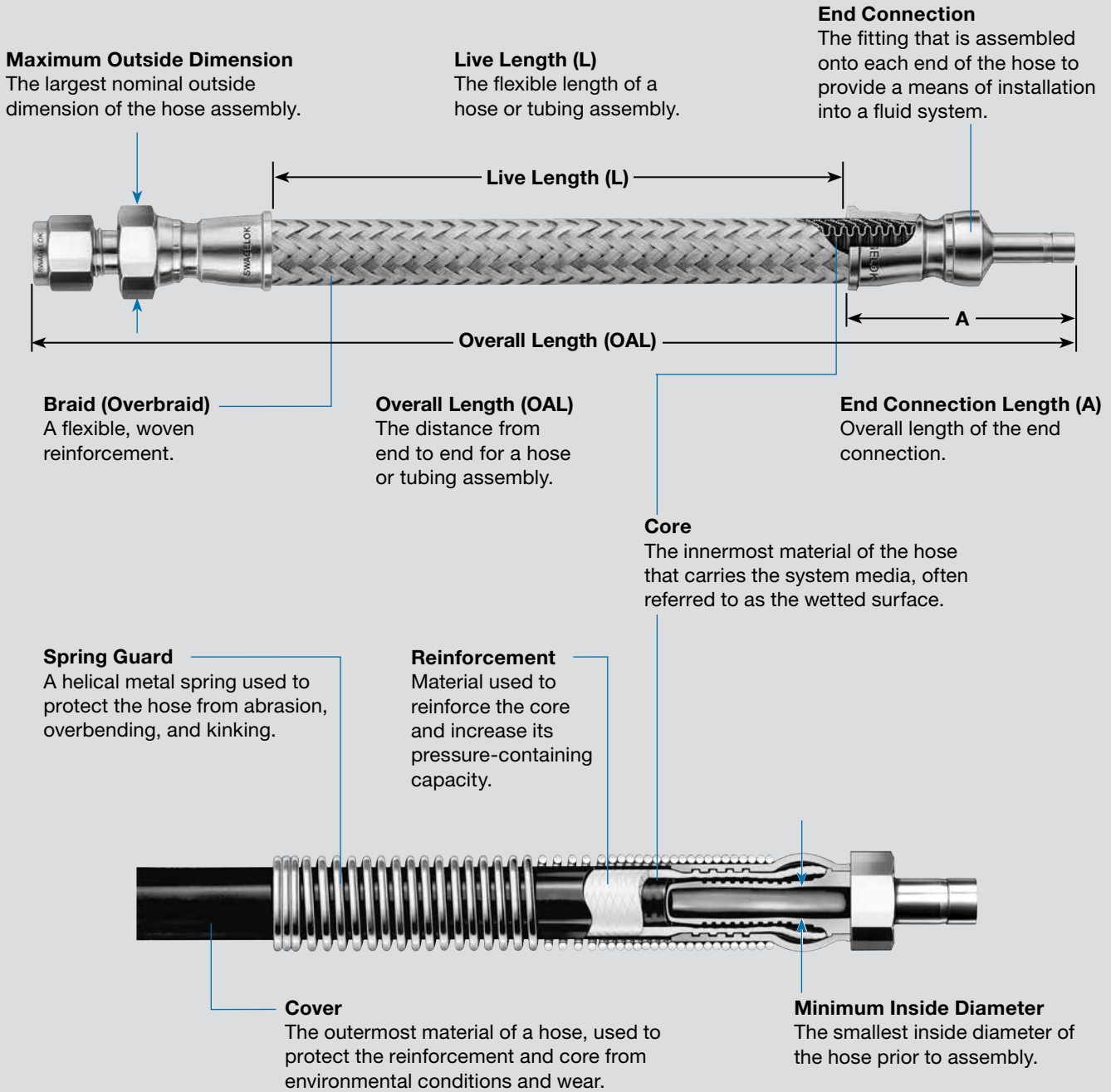

Swagelok Hose and Flexible Tubing Selection Guide

See individual hose series sections for additional technical information.

Series	Materials of Construction			Page
	Core	Reinforcement	Cover	
Metal Hose				
FX	Convuluted 316L SS	321 SS braid standard; 316L SS braid available	—	11
FM	Convuluted 316L SS	316L SS braid	—	16
FJ	Convuluted 316L SS	304 SS braid standard; 316L SS braid available	—	22
FL	Convuluted 316L SS	321 SS braid (1/4 and 1/2 in.) 316L SS braid (all other sizes)	—	27
AH	Convuluted C-276	316L SS braid	—	33
FV	Convuluted 316L SS	304L SS braid	Convuluted 316L SS	37
Metal Flexible Tubing				
FN	Convuluted 316L SS, annealed	—	—	40
FZ	Convuluted 316L SS	—	—	42
Fluoropolymer Hose				
T	Smooth-bore PTFE ^①	304 SS braid standard; 316L SS and alloy 400 braid available	—	49
B	Smooth-bore PTFE	304 SS braid	—	55
X	Smooth-bore PTFE ^①	Fiber braid with 304 SS braid	—	57
S	Smooth-bore PTFE ^①	Fiber braid with 304 SS braid	White silicone	59
C	Convuluted PTFE ^①	304 SS braid	—	61
J	Convuluted PTFE	304 SS braid	White silicone	63
N	Convuluted, carbon black-filled PTFE	Insulating wrap and aramid fiber braid	—	65
W	Smooth-bore, carbon black-filled PTFE	Fiber braid with insulating wrap and 304 SS braid	Silicone (different colors available)	67
F	Smooth-bore PTFE ^①	Fiber braid	—	69
U	Smooth-bore PFA ^②	302 SS braid	White silicone	71
PFA Tubing				
PFA	Smooth-bore PFA	—	—	83
Vinyl Tubing				
LT	Smooth-bore clear vinyl	—	—	85
Nylon Hose				
NG	Smooth-bore, static dissipative nylon	Fiber braid	Perforated black polyurethane	89
7R	Smooth-bore nylon	Fiber braid	Perforated black polyurethane	94
8R	Smooth-bore nylon	Fiber braid	Perforated black polyurethane	94
7N	Smooth-bore, nonconductive nylon	Fiber braid	Nonperforated orange polyurethane	95
Polyethylene Hose				
7P	Smooth-bore polyethylene	Fiber braid	Nonperforated blue polyurethane	100
Rubber Hose				
PB	Smooth-bore Buna N	Synthetic fiber braid	Blue Buna N (other colors available)	102

^① Carbon black-filled PTFE core is available for applications that require static dissipation.

^② Carbon black-filled PFA core is available for applications that require static dissipation.

Swagelok Hose and Flexible Tubing Selection Guide

See individual hose series sections for additional technical information.

Series	Nominal Hose Size, in.										Temperature Range °F (°C) ^④	Page
	Working Pressure at 70°F (20°C), psig (bar) ^④											
	1/8	3/16	1/4	3/8	1/2	3/4	1	1 1/4	1 1/2	2		
Metal Hose												
FX	—	—	6000 (413)	5000 (344)	4500 (310)	3600 (248)	3000 (206)	2600 (179)	2200 (151)	1675 (115)	-325 to 1000 (-200 to 537)	11
FM	—	—	3100 (213)	2000 (137)	1800 (124)	1500 (103)	1200 (82.6)	1200 (82.6)	1100 (75.7)	700 (48.2)	-325 to 850 (-200 to 454)	16
FJ	—	—	1600 (110)	1470 (101)	1110 (76.4)	860 (59.2)	680 (46.8)	680 (46.8)	520 (35.8)	450 (31.0)	-325 to 800 (-200 to 426)	22
FL	—	—	1500 (103)	1470 (101)	1200 (82.6)	860 (59.2)	680 (46.8)	645 (44.4)	520 (35.8)	380 (26.1)	-325 to 850 (-200 to 454)	27
AH	—	—	—	—	1110 (76.4)	860 (59.2)	680 (46.8)	—	520 (35.8)	450 (31.0)	-325 to 800 (-200 to 426)	33
FV	—	—	—	—	600 (41.3)	490 (33.7)	400 (27.5)	—	—	—	-425 to 1000 (-253 to 537)	37
Metal Flexible Tubing												
FN	—	—	135 (9.3)	65 (4.4)	60 (4.1)	23 (1.5)	18 (1.2)	—	10 (0.68)	6 (0.41)	-325 to 1000 (-200 to 537)	40
FZ	—	—	250 (17.2)	105 (7.2)	95 (6.5)	—	—	—	—	—		42
Fluoropolymer Hose												
T	—	—	3000 ^① (206)	2500 (172)	2000 (137)	1500 (103)	1000 (68.9)	—	—	—	-65 to 450 (-53 to 230)	49
B	3000 (206)	—	—	—	—	—	—	—	—	—		55
X	—	—	3500 (241)	3000 (206)	1800 (124)	1250 (86.1)	1000 (68.9)	—	—	—	-100 to 450 ^⑤ (-73 to 230)	57
S	3000 (206)	—	3500 (241)	3000 (206)	1800 (124)	1250 (86.1)	1000 (68.9)	—	—	—	-65 to 400 (-53 to 204)	59
C	—	—	—	—	1500 (103)	1100 (75.7)	750 (51.6)	—	700 (48.2)	525 (36.1)	-65 to 450 ^② (-53 to 230)	61
J	—	—	—	—	1500 (103)	1100 (75.7)	750 (51.6)	—	—	—	-65 to 400 (-53 to 204)	63
N	—	—	—	1250 (86.1)	750 (51.6)	375 (25.8)	—	—	—	—	-65 to 450 (-53 to 230)	65
W	—	—	—	750 (51.6)	750 (51.6)	500 (34.4)	—	—	—	—	-65 to 400 (-53 to 204)	67
F	—	—	800 (55.1)	650 (44.7)	450 (31.0)	325 (22.3)	—	—	—	—	-65 to 450 (-53 to 230)	69
U	—	—	—	—	300 (20.6)	300 (20.6)	250 (17.2)	—	200 (13.7)	150 (10.3)	-65 to 400 (-53 to 204)	71
PFA Tubing												
PFA	275 (18.9)	—	275 (18.9)	180 (12.4)	125 (8.6)	83 (5.7)	61 (4.2)	—	—	—	70 to 400 (20 to 204)	83
Vinyl Tubing												
LT	40 (2.7)	30 (2.0)	25 (1.7)	15 (1.0)	10 (0.68)	—	—	—	—	—	-40 to 165 (-40 to 73)	85
Nylon Hose												
NG	—	—	5000 (344)	5000 (344)	5000 (344)	—	—	—	—	—	-40 to 150 (-40 to 65)	89
7R	—	—	2750 (189)	2250 (155)	2000 (137)	—	—	—	—	—	-40 to 200 (-40 to 93)	94
8R	—	—	5000 (344)	4000 (275)	3500 (241)	—	—	—	—	—	-40 to 200 (-40 to 93)	94
7N	—	—	2750 (189)	2250 (155)	2000 (137)	—	—	—	—	—	-40 to 200 (-40 to 93)	95
Polyethylene Hose												
7P	—	—	2750 (189)	2250 (155)	2000 (137)	—	—	—	—	—	-10 to 150 (-23 to 65)	100
Rubber Hose												
PB	—	—	350 (24.1)	300 (20.6)	300 (20.6)	300 (20.6)	300 (20.6)	—	—	—	-40 to 200 ^③ (-40 to 93)	102

① T series hose with alloy 400 braid is rated to 1500 psig (103 bar). ② C series hose is rated from -20 to 340°F (-28 to 171°C) in the 1 1/2 and 2 in. nominal hose sizes.

③ PB series hose is rated from -20 to 200°F (-28 to 93°C) in the 1 in. nominal hose size. ④ Pressure-temperature ratings may be limited by the end connections.

⑤ X series hose is rated from -65 to 450°F (-53 to 230°C) in the 1/4 and 3/8 in. nominal sizes

Considerations for Selecting a Hose Assembly Solution

Temperature

Identify the minimum and maximum temperatures the hose assembly will be exposed to with regard to the system media and the environment.

Pressure

Identify the minimum and maximum pressures (or vacuum) within and outside the hose assembly.

Material

Identify the system media and the environment to which the hose assembly will be exposed. This will help determine the materials of construction best suited to the application demands and whether the hose requires a static dissipative core.

Movement

Confirm whether the hose assembly will be installed in dynamic applications as this will require different considerations than a static application.

Length

Determine the most likely route for installation of the hose, and use this to identify length requirements.

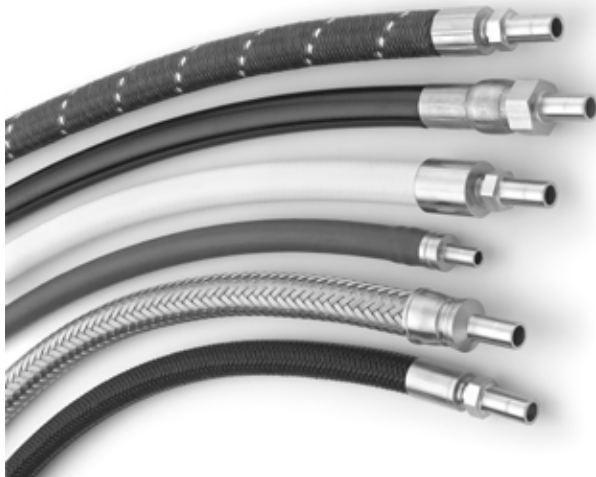

Cleanliness

Identify the need for cleanliness. Ease of cleaning the internal surfaces of the hose, as well as maintaining outside cleanliness may be of concern.

End Connection

Identify the type of end connections which are most compatible with the system requirements. End connections differ with regard to materials of construction and pressure ratings.

Orientation

Clarify space constraint concerns. Hose assemblies with elbows and union ball joints may help resolve space constraint issues.

Desired Flow

Consider desired flow. Hose connection size, core tube construction, and routed installation may impact flow.

Drainability

Consider core construction as this will impact drainability.

Test Reports

Identify the need for documentation in the form of test reports.

Special Testing

Many applications may require testing to requirements different from the production tests listed. For example, metal hose assemblies undergo an inboard helium leak test to a maximum leak rate of 1×10^{-5} std cm³/s. If your application uses liquid at a positive pressure, you may request an additional hydrostatic proof test.

Special Marking

Discuss special marking requirements; there are different options available to readily identify hose assemblies.

Documentation and Regulatory Requirements

Identify the need for special regulatory approvals or documentation.

Additional Protection and Covers

Identify whether covers are necessary for additional protection of the hose assemblies or surrounding systems.

Additional Considerations

- Use of hose and tubing within applications and handling practices will affect how it performs over time. Catalog performance claims such as burst pressure, working pressure, static dissipation, moisture content, permeation rates, and cycle life apply to never-used products. For this reason, system maintenance and replacement schedules should be considered.

Cautions

- ⚠ **Nylon, PFA, polyethylene, PTFE, and rubber are permeable materials. Gases, vapors, and liquids may migrate through cores of these materials. The rate of permeation is affected by many application-specific variables.**
- ⚠ **Nonperforated covers may blister in gas service.**
- ⚠ **Thermal cycling of any nonmetal hose may affect its ability to maintain a positive seal. Testing should be performed to verify suitability in actual operating conditions.**
- ⚠ **All equipment must be properly grounded to allow static dissipation and help to prevent static sparking.**
- ⚠ **Nonconductive hoses can be conduits for electricity if they contain conductive fluids. Verify the conductive properties of the system media prior to use.**

Swagelok Hose and Flexible Tubing Installation and Use Guide

Inspection

Establish an inspection schedule based on system application and replacement history.

Electrostatic Discharge

Static electricity can be generated by fluid passing through the hose. Select hose with sufficient conductivity to ground the static electric charge and allow static dissipation. If static electricity generation is possible within an application, choose static dissipative hose and properly ground to earth.

Vibration

Evaluate amount of system vibration when selecting hose. Metal hose may not be appropriate for systems with constant or severe vibration.

Length

Take into consideration hose movement, system pressurization, and thermal expansion when determining hose length. Installing hose that does not have sufficient length to accommodate these factors may reduce hose life.

Minimum Bend Radius

Follow minimum bend radius requirements for your hose. Installing hose with smaller bends may kink hose and reduce hose life.

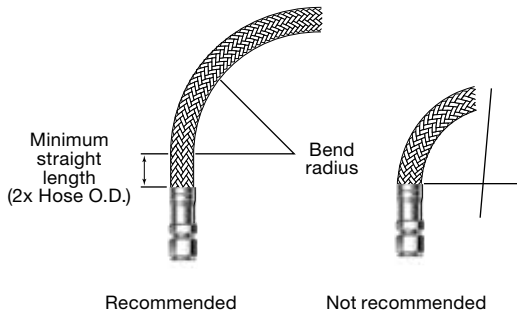

Hose rupture or leakage may result from bending too close to the hose/fitting connection.

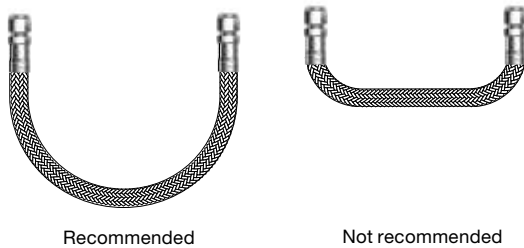

Hose Strain

Elbows and adapters can be used to relieve hose strain.

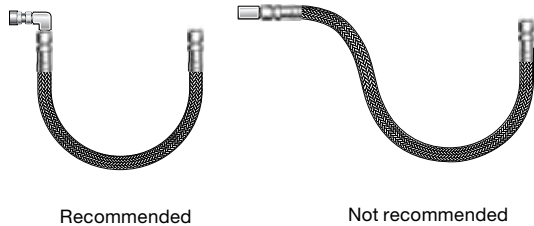

Motion Absorption

Distribute movement and prevent bends smaller than the hose's minimum bend radius by providing sufficient hose length.

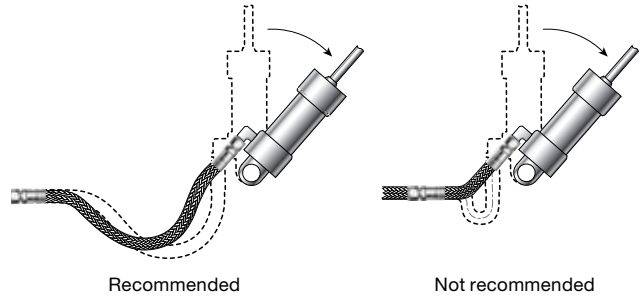

Machine Tolerance

Allow for changes in length resulting from machine motion and tolerances.

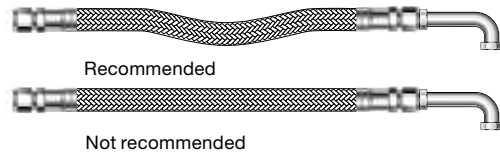

System Pressure Changes

Allow sufficient hose length to accommodate changing system pressures. Do not connect high- and low pressure hoses

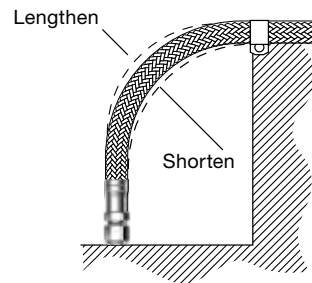

Bending in One Plane

Avoid twisting the hose by bending it in one plane only. For a compound bend, use multiple hose pieces or other isolation methods.

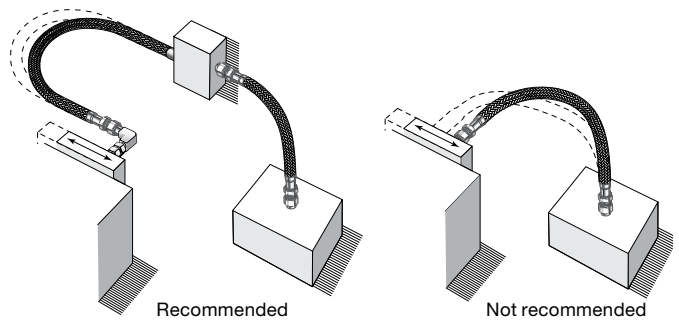

For additional information, see SAE J1273, *Recommended Practices for Hydraulic Hose Assemblies*.

FX Series Metal Hose

Features

- High-pressure corrosion resistant all-metal hose.
- 316L stainless steel annular convoluted core.
- Size range of 1/4 through 2 in. and working pressures from vacuum to 6000 psig (413 bar).
- Double braid layers of 321 stainless steel promotes hose pressure containment.
- End connections welded in accordance with ASME Boiler and Pressure Vessel Code Section IX.
- Commonly used in high-temperature vacuum and high-pressure corrosive environments or where permeation is undesirable.
- Custom assemblies available.
- Options include hose covers, hose tags, additional cleaning, and additional helium leak testing. See page 107 for details.
- For electrical properties, see page 5 for details.

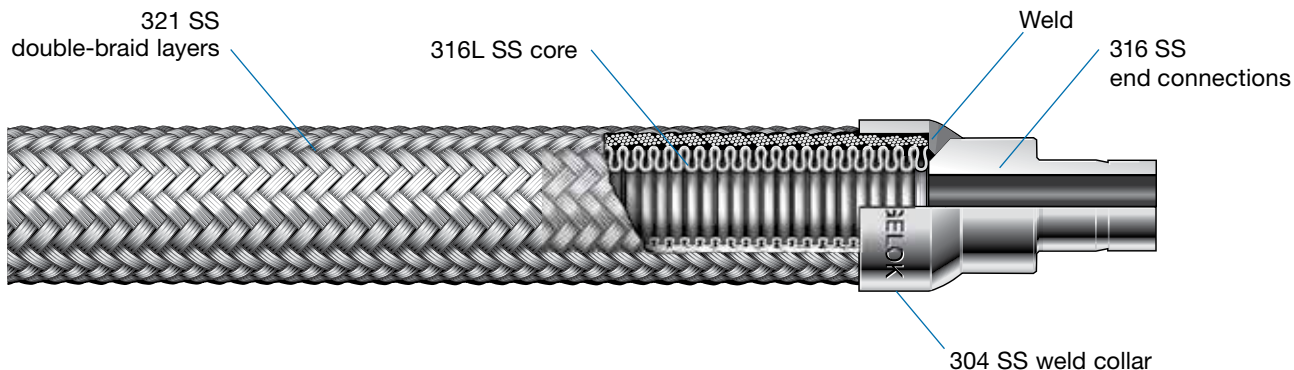

Technical Data

Nominal Hose Size in. (mm)	Inside Diameter in. (mm)	Outside Diameter in. (mm)	Minimum Center Line Bend Radius in. (cm)		Temperature Range °F (°C)	Working Pressure at -325 to 300°F (-200 to 148°C) Vacuum to ... psig (bar)	Minimum Burst Pressure at 70°F (20°C) psig (bar)	Bulk Hose Weight lb/ft (kg/m)
			Static	Dynamic				
1/4 (6.4)	0.25 (6.4)	0.71 (18.0)	1.5 (3.81)	5.5 (14.0)	-325 to 1000 (-200 to 537)	6000 (413)	24 000 (1653)	0.49 (0.73)
3/8 (9.7)	0.38 (9.5)	0.94 (23.9)	2.5 (6.40)	7.0 (17.8)		5000 (344)	20 000 (1378)	0.77 (1.15)
1/2 (12.7)	0.51 (13.0)	1.01 (25.7)	3.0 (7.62)	8.0 (20.3)		4500 (310)	18 000 (1240)	0.85 (1.26)
3/4 (19.0)	0.75 (19.0)	1.44 (36.4)	4.0 (10.2)	10.0 (25.4)		3600 (248)	14 400 (992)	1.58 (2.35)
1 (25.4)	1.00 (25.4)	1.73 (43.9)	5.0 (12.7)	11.0 (27.9)		3000 (206)	12 000 (826)	2.32 (3.45)
1 1/4 (31.8)	1.25 (31.8)	2.03 (51.6)	6.5 (16.5)	12.5 (31.8)		2600 (179)	10 400 (716)	2.88 (4.29)
1 1/2 (38.1)	1.50 (38.1)	2.40 (60.9)	7.5 (19.1)	13.0 (33.0)		2200 (151)	8 800 (606)	3.57 (5.31)
2 (50.8)	2.00 (50.8)	2.85 (72.4)	9.0 (22.9)	14.0 (35.6)		1675 (115)	6 700 (461)	4.45 (6.62)

Pressure-temperature ratings may be limited by the end connections.

Pressure-Temperature Ratings

Ratings are based on ASME Code for Pressure Piping B31.3, Process Piping.

Nominal Hose Size, in.	1/4	3/8	1/2	3/4	1	1 1/4	1 1/2	2
Temperature °F (°C)	Working Pressure Vacuum to ... psig (bar)							
-325 (-200)	6000 (413)	5000 (344)	4500 (310)	3600 (248)	3000 (206)	2600 (179)	2200 (151)	1675 (115)
300 (148)	400 (204)	5640 (388)	4700 (323)	4230 (291)	3384 (233)	2820 (194)	2444 (168)	2068 (142)
400 (204)	500 (260)	5317 (366)	4431 (305)	3988 (274)	3190 (219)	2658 (183)	2304 (158)	1949 (134)
500 (260)	600 (315)	5029 (346)	4191 (288)	3772 (259)	3017 (207)	2514 (193)	2179 (150)	1844 (127)
600 (315)	700 (371)	4850 (334)	4041 (278)	3637 (250)	2910 (200)	2425 (167)	2101 (144)	1778 (122)
700 (371)	800 (426)	4634 (319)	3862 (266)	3476 (239)	2780 (191)	2317 (159)	2008 (138)	1699 (117)
800 (426)	850 (454)	4562 (314)	3802 (261)	3422 (235)	2737 (188)	2281 (157)	1977 (136)	1673 (115)
850 (454)	900 (482)	4455 (306)	3712 (255)	3341 (230)	2673 (184)	2227 (153)	1930 (132)	1633 (112)
900 (482)	950 (510)	4347 (299)	3622 (249)	3260 (224)	2608 (179)	2173 (149)	1883 (129)	1594 (109)
950 (510)	1000 (537)	4239 (292)	3532 (243)	3179 (219)	2543 (175)	2119 (145)	1837 (126)	1554 (107)
1000 (537)								1183 (81.5)

FX Series Metal Hose

Testing

Every Swagelok FX series hose assembly is inboard helium leak tested to a maximum leak rate of 1×10^{-5} std cm³/s.

For additional testing, see **Testing**, page 108.

Cleaning and Packaging

Swagelok FX series hose components are cleaned in accordance with Swagelok *Standard Cleaning and Packaging (SC-10)* catalog, [MS-06-62](#). Each hose is bagged individually and boxed; longer hoses are coiled, bagged, and boxed.

⚠ Do not subject flexible metal hose to pressure surges, shock, or pulsations, where the peak pressure is greater than 50 % of the working pressure rating.

Ordering Information

Custom Hose Assemblies

Build a hose assembly ordering number by combining the designators in the sequence shown below.

Typical Ordering Number

1 2 3 4 4 5 6 5 6
SS - FX 4 TA4 PM4 - 28 - F or **71 CM - F**
└─── in. ───┘ or └─── cm ───┘

1 Material

End Connections

SS = 316 stainless steel

2 Hose

FX = FX series high-pressure metal hose

3 Nominal Hose Size, in.

4 = 1/4	16 = 1
6 = 3/8	20 = 1 1/4
8 = 1/2	24 = 1 1/2
12 = 3/4	32 = 2

4 End Connections

See **End Connection Designator** column in tables on next page.

5 Overall Length

Inches in tenths or centimeters, in whole numbers. Include **CM** as shown for centimeter lengths.

6 Options

For multiple options, add designators with a dash between each designator.

- A** = Armor guard
- F** = Fire jacket
- C** = ASTM G93 Level C cleaning on hose wetted surfaces
- G** = CGA 4.1 cleaning on hose wetted surfaces
- F1** = Thermosleeve
- H7** = Helium leak test (1×10^{-7} std cm³/s)
- N3** = Nitrogen pressure test
- Z** = 316L SS collar and braid material

Mat Tags

- | | |
|-------------------|--------------------|
| MA = Gray | MO = Orange |
| MB = Blue | MP = Purple |
| MC = Brown | MR = Red |
| MG = Green | MW = White |
| MK = Black | MY = Yellow |
| MN = Pink | |

Add 2 to the end of the Mat Tag designator for two tags.

Example: MA2

Other Tags

- T** = Lanyard tag
- T2** = Two lanyard tags
- T5** = Clamp tag

Specify text for tags. See **Hose Tag Text** table, page 109.

See page 107 for detailed descriptions of options.

FX Series Metal Hose

End Connections

Swagelok Tube Adapters

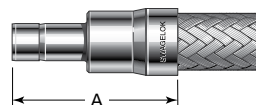

1 in. and Under

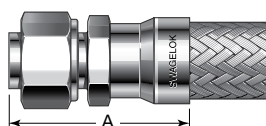

Preswaged
Nuts and Ferrules—
Over 1 in. / 25 mm

Tube Adapter Size	Nominal Hose Size Designator	End Connection Designator	Dimensions		
			A	Minimum Inside Diameter	Maximum Outside Dimension
Dimensions, in. (mm)					
1/4	4	TA4	1.64 (41.7)	0.18 (4.6)	0.78 (19.8)
3/8	6	TA6	1.81 (46.0)	0.27 (6.9)	1.01 (25.7)
1/2	8	TA8	2.28 (57.9)	0.37 (9.4)	1.08 (27.4)
3/4	12	TA12	2.62 (66.5)	0.58 (14.7)	1.50 (38.1)
1	16	TA16	2.99 (75.9)	0.80 (20.3)	1.79 (45.5)
1 1/4 ^①	20	TA20	3.91 (99.3)	1.02 (25.9)	2.16 (54.9)
1 1/2 ^①	24	TA24	4.47 (114)	1.25 (31.8)	2.59 (65.8)
2 ^①	32	TA32	5.70 (145)	1.72 (43.7)	3.45 (87.6)
Dimensions, mm (in.)					
6	4	TM6	42.2 (1.66)	4.1 (0.16)	19.8 (0.78)
8	4	TM8	42.4 (1.67)	5.6 (0.22)	19.8 (0.78)
10	6	TM10	53.3 (2.10)	7.1 (0.28)	25.7 (1.01)
12	8	TM12	67.9 (2.67)	8.9 (0.35)	27.4 (1.08)
18	12	TM18	64.0 (2.52)	14.0 (0.55)	38.1 (1.50)
25	16	TM25	75.9 (2.99)	19.8 (0.78)	45.5 (1.79)
32 ^①	20	TM32	87.4 (3.44)	26.4 (1.04)	57.4 (2.26)
38 ^①	24	TM38	97.3 (3.83)	31.8 (1.25)	69.1 (2.72)

① Furnished with nut, preswaged silver-plated front ferrule, and uncoated back ferrule which are required for performance above 450°F (232°C).

Swagelok Tube Fittings



Tube Fitting Size	Nominal Hose Size Designator	End Connection Designator	Dimensions		
			A	Minimum Inside Diameter	Maximum Outside Dimension
Dimensions, in. (mm)					
1/4	4	SL4	1.99 (50.5)	0.19 (4.8)	0.78 (19.8)
3/8	6	SL6	2.07 (52.6)	0.28 (7.1)	1.01 (25.7)
1/2	8	SL8	2.56 (65.0)	0.41 (10.4)	1.08 (27.4)
3/4	12	SL12	2.74 (69.6)	0.63 (16.0)	1.50 (38.1)
1	16	SL16	3.20 (81.3)	0.88 (22.4)	1.79 (45.5)
1 1/4 ^①	20	SL20	3.79 (96.3)	1.09 (27.7)	2.10 (53.3)
1 1/2 ^①	24	SL24	4.25 (108)	1.35 (34.3)	2.45 (62.2)
2 ^①	32	SL32	5.47 (139)	1.82 (46.2)	3.17 (80.5)
Dimensions, mm (in.)					
6	4	SM6	50.5 (1.99)	4.8 (0.19)	19.8 (0.78)
8	4	SM8	51.6 (2.03)	6.4 (0.25)	19.8 (0.78)
10	6	SM10	53.6 (2.11)	7.9 (0.31)	25.7 (1.01)
12	8	SM12	65.0 (2.56)	9.7 (0.38)	27.4 (1.08)
18	12	SM18	69.6 (2.74)	15.0 (0.59)	38.1 (1.50)
25	16	SM25	81.3 (3.20)	21.8 (0.86)	45.5 (1.79)
32 ^①	20	SM32	98.8 (3.89)	28.7 (1.13)	53.3 (2.10)
38 ^①	24	SM38	111 (4.36)	33.8 (1.33)	63.2 (2.49)

① Furnished with silver-plated front ferrule and uncoated back ferrule which are required for performance above 450°F (232°C).

FX Series Metal Hose

Rotatable Male VCR® Metal Gasket Face Seal Fittings

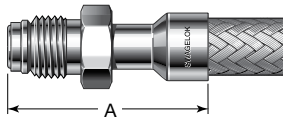

VCR Size in.	Nominal Hose Size Designator	End Connection Designator	Dimensions, in. (mm)		
			A	Minimum Inside Diameter	Maximum Outside Dimension
1/4	4	RM4	1.81 (46)	0.18 (4.6)	0.78 (19.8)
1/2	8	RM8	2.13 (54.1)	0.40 (10.2)	1.08 (27.4)
3/4	12	RM12	2.75 (69.9)	0.63 (16.0)	1.51 (38.4)
1	16	RM16	2.97 (75.4)	0.88 (22.4)	1.88 (47.8)

Rotatable Female VCR Metal Gasket Face Seal Fittings

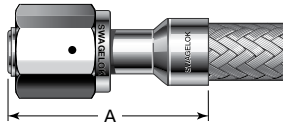

VCR Size in.	Nominal Hose Size Designator	End Connection Designator	Dimensions, in. (mm)		
			A	Minimum Inside Diameter	Maximum Outside Dimension
1/4	4	RF4	1.81 (46)	0.18 (4.6)	0.87 (22.1)
1/2	8	RF8	2.13 (54.1)	0.40 (10.2)	1.23 (31.2)
3/4	12	RF12	2.75 (69.9)	0.63 (16.0)	1.73 (43.9)
1	16	RF16	2.97 (75.4)	0.88 (22.4)	2.02 (51.3)

Female VCO O-Ring Face Seal Fittings

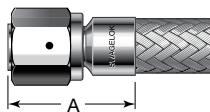

VCO Size in.	Nominal Hose Size Designator	End Connection Designator	Dimensions, in. (mm)		
			A	Minimum Inside Diameter	Maximum Outside Dimension
1/4	4	VF4	1.27 (32.3)	0.19 (4.8)	0.79 (20.1)
1/2	8	VF8	1.44 (36.6)	0.41 (10.4)	1.08 (27.4)
3/4	12	VF12	1.69 (42.9)	0.63 (16.0)	1.73 (43.9)
1	16	VF16	1.73 (43.9)	0.88 (22.4)	2.02 (51.3)

SAE 37° (JIC) Female Swivel

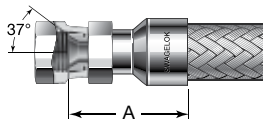

Swivel Size in.	Nominal Hose Size Designator	End Connection Designator	Dimensions, in. (mm)		
			A	Minimum Inside Diameter	Maximum Outside Dimension
1/4	4	AS4	1.33 (33.8)	0.19 (4.8)	0.78 (19.8)
3/8	6	AS6	1.54 (39.1)	0.28 (7.1)	1.01 (25.7)
1/2	8	AS8	1.64 (41.7)	0.39 (9.9)	1.08 (27.4)
3/4	12	AS12	1.88 (47.8)	0.61 (15.5)	1.50 (38.1)
1	16	AS16	2.08 (52.8)	0.84 (21.3)	1.79 (45.5)

FX Series Metal Hose

Female Pipe Threads, NPT

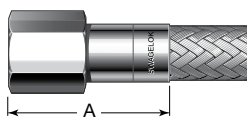

NPT Size in.	Nominal Hose Size Designator	End Connection Designator	Dimensions, in. (mm)		
			A	Minimum Inside Diameter	Maximum Outside Dimension
1/4	4	PF4	1.72 (43.7)	0.30 (7.6)	0.87 (22.1)
3/8	6	PF6	1.84 (46.7)	0.42 (10.7)	1.01 (25.7)
1/2	8	PF8	2.58 (65.5)	0.58 (14.7)	1.23 (31.2)
3/4	12	PF12	2.53 (64.3)	0.73 (18.5)	1.51 (38.4)
1	16	PF16	2.92 (74.2)	0.95 (24.1)	1.88 (47.8)
1 1/2	24	PF24	3.28 (83.3)	1.50 (38.1)	2.74 (69.6)

Male Pipe Threads, NPT and ISO/BSP Tapered (ISO 7)

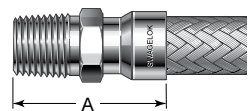

NPT and ISO/BSP Tapered Size in.	Nominal Hose Size Designator	End Connection Designator	Dimensions, in. (mm)		
			A	Minimum Inside Diameter	Maximum Outside Dimension
NPT					
1/4	4	PM4	1.82 (46.2)	0.28 (7.1)	0.78 (19.8)
3/8	6	PM6	1.91 (48.5)	0.38 (9.7)	1.01 (25.7)
1/2	8	PM8	2.45 (62.2)	0.47 (11.9)	1.08 (27.4)
3/4	12	PM12	2.57 (65.3)	0.63 (16.0)	1.50 (38.1)
1	16	PM16	3.05 (77.5)	0.88 (22.4)	1.79 (45.5)
1 1/4	20	PM20	3.14 (79.8)	1.09 (27.7)	2.10 (53.3)
1 1/2	24	PM24	3.38 (85.9)	1.34 (34.0)	2.45 (62.2)
2	32	PM32	3.88 (98.6)	1.81 (46.0)	2.92 (74.2)
ISO/BSP Tapered					
1/4	4	MT4	1.82 (46.2)	0.28 (7.1)	0.78 (19.8)
3/8	6	MT6	1.91 (48.5)	0.38 (9.7)	1.01 (25.7)
1/2	8	MT8	2.45 (62.2)	0.47 (11.9)	1.08 (27.4)
3/4	12	MT12	2.57 (65.3)	0.63 (16.0)	1.50 (38.1)
1	16	MT16	3.05 (77.5)	0.88 (22.4)	1.79 (45.5)
1 1/4	20	MT20	3.14 (79.8)	1.09 (27.7)	2.10 (53.3)
1 1/2	24	MT24	3.38 (85.9)	1.34 (34.0)	2.45 (62.2)

Tube Butt Welds

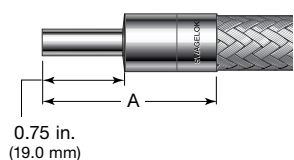

Tube Butt Weld Size in.	Wall Thickness in.	Nominal Hose Size Designator	End Connection Designator	Dimensions, in. (mm)		
				A	Minimum Inside Diameter	Maximum Outside Dimension
1/4	0.035	4	TB4	1.77 (45.0)	0.18 (4.6)	0.78 (19.8)
3/8	0.035	6	TB6	1.82 (46.2)	0.31 (7.9)	1.01 (25.7)
1/2	0.049	8	TB8	2.17 (55.1)	0.40 (10.2)	1.08 (27.4)
3/4	0.049	12	TB12	2.27 (57.7)	0.65 (16.5)	1.50 (38.1)
1	0.065	16	TB16	2.46 (62.5)	0.87 (22.1)	1.79 (45.5)

FM Series Metal Hose

Features

- All-metal hose promotes corrosion resistance.
- 316L stainless steel annular convoluted core.
- Size range of 1/4 through 2 in. and working pressures from vacuum to 3100 psig (213 bar).
- Single braid layer of 316L stainless steel promotes hose pressure containment and exhibits strong performance in dynamic cycling applications.
- End connections welded in accordance with ASME Boiler and Pressure Vessel Code Section IX.
- Commonly used in high-temperature vacuum applications and medium-pressure corrosive environments, or where permeation is undesirable.
- Standard and custom assemblies available.
- Options include hose covers, hose tags, additional cleaning, and additional helium leak testing. See page 107 for details.
- For electrical properties, see page 5 for details.

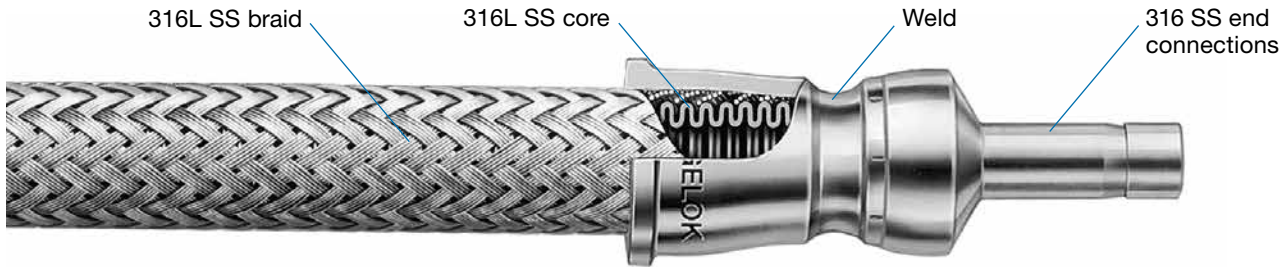

Technical Data

Nominal Hose Size in. (mm)	Inside Diameter in. (mm)	Outside Diameter in. (mm)	Minimum Center Line Bend Radius in. (cm)		Temperature Range °F (°C)	Working Pressure at -325 to 100°F (-200 to 37°C) Vacuum to ... psig (bar)	Minimum Burst Pressure at 70°F (20°C) psig (bar)	Bulk Hose Weight lb/ft (kg/m)
			Static	Dynamic				
1/4 (6.4)	0.28 (7.1)	0.53 (13.5)	2.25 (5.72)	10.0 (25.4)	-325 to 850 (-200 to 454)	3100 (213)	12 400 (854)	0.29 (0.43)
3/8 (9.7)	0.42 (10.6)	0.69 (17.5)	3.00 (7.62)	12.0 (30.5)		2000 (137)	8 000 (551)	0.33 (0.49)
1/2 (12.7)	0.53 (13.5)	0.85 (21.6)	4.50 (11.4)	16.0 (40.6)		1800 (124)	7 200 (496)	0.45 (0.67)
3/4 (19.0)	0.80 (20.3)	1.15 (29.1)	6.00 (15.2)	17.0 (43.2)		1500 (103)	6 000 (413)	0.62 (0.92)
1 (25.4)	1.03 (26.0)	1.45 (36.9)	6.75 (17.1)	20.0 (50.8)		1200 (82.6)	4 800 (330)	0.77 (1.15)
1 1/4 (31.8)	1.25 (31.8)	1.90 (48.3)	4.50 (11.4)	12.5 (31.8)		1200 (82.6)	4 800 (330)	2.09 (3.11)
1 1/2 (38.1)	1.50 (38.1)	2.26 (57.4)	5.25 (13.3)	13.0 (33.0)		1100 (75.7)	4 400 (303)	2.64 (3.93)
2 (50.8)	2.00 (50.8)	2.72 (69.1)	6.75 (17.1)	14.0 (35.6)		700 (48.2)	2 800 (192)	3.23 (4.81)

Pressure-Temperature Ratings

Ratings are based on ASME Code for Pressure Piping, B31.1 Power Piping, and ASME Boiler and Pressure Vessel Code.

Nominal Hose Size, in.	1/4	3/8	1/2	3/4	1	1 1/4	1 1/2	2
Temperature, °F (°C)	Working Pressure, vacuum to ... psig (bar)							
-325 (-200) to 100 (37)	3100 (213)	2000 (137)	1800 (124)	1500 (103)	1200 (82.6)	1200 (82.6)	1100 (75.7)	700 (48.2)
200 (93)	2604 (179)	1680 (115)	1512 (104)	1260 (86.8)	1008 (69.4)	1008 (69.4)	924 (63.6)	588 (40.5)
300 (148)	2356 (162)	1520 (104)	1368 (94.2)	1140 (78.5)	912 (62.8)	912 (62.8)	836 (57.6)	532 (36.6)
400 (204)	2170 (149)	1400 (96.4)	1260 (86.8)	1050 (72.3)	840 (57.8)	840 (57.8)	770 (53.0)	490 (33.7)
500 (260)	2015 (138)	1300 (89.5)	1170 (80.6)	975 (67.1)	780 (53.7)	780 (53.7)	715 (49.2)	455 (31.3)
600 (315)	1922 (132)	1240 (85.4)	1116 (76.8)	930 (64.0)	744 (51.2)	744 (51.2)	682 (46.9)	434 (29.9)
700 (371)	1829 (126)	1180 (81.3)	1062 (73.1)	885 (60.9)	708 (48.7)	708 (48.7)	649 (44.7)	413 (28.4)
800 (426)	1767 (121)	1140 (78.5)	1026 (70.6)	855 (58.9)	684 (47.1)	684 (47.1)	627 (43.2)	399 (27.4)
850 (454)	1736 (119)	1120 (77.1)	1008 (69.4)	840 (57.8)	672 (46.3)	672 (46.3)	616 (42.4)	392 (27.0)

FM Series Metal Hose

Testing

Every Swagelok FM series hose assembly is inboard helium leak tested to a maximum leak rate of 1×10^{-5} std cm³/s.

For additional testing, see **Testing**, page 108.

Cleaning and Packaging

Swagelok FM series hose components are cleaned in accordance with Swagelok *Standard Cleaning and Packaging (SC-10)* catalog, [MS-06-62](#). Each hose is bagged individually and boxed; longer hoses are coiled, bagged, and boxed.

⚠ Do not subject flexible metal hose to pressure surges, shock, or pulsations, where the peak pressure is greater than 50 % of the working pressure rating.

Ordering Information and Dimensions

Standard Length Hose Assemblies

Select an ordering number.

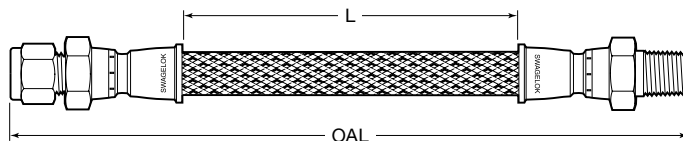

Swagelok Tube Fitting to Male NPT End Connection



Nominal Hose Size in.	Tube Fitting Size in.	NPT Size in.	Overall Length OAL in. (cm)	Ordering Number	Dimensions		
					Live Length L in. (cm)	Minimum Inside Diameter in. (mm)	Maximum Outside Dimension in. (mm)
1/4	1/4	1/4	12.0 (30.5)	SS-FM4SL4PM4-12	8.26 (21.0)	0.19 (4.8)	0.95 (24.1)
			36.0 (91.4)	SS-FM4SL4PM4-36	32.3 (82.0)		
3/8	3/8	3/8	18.0 (45.7)	SS-FM6SL6PM6-18	14.2 (36.1)	0.28 (7.1)	1.09 (27.7)
			36.0 (91.4)	SS-FM6SL6PM6-36	32.2 (81.8)		
1/2	1/2	1/2	18.0 (45.7)	SS-FM8SL8PM8-18	13.6 (34.5)	0.41 (10.4)	1.23 (31.2)
			48.0 (122)	SS-FM8SL8PM8-48	43.6 (111)		
3/4	3/4	3/4	18.0 (45.7)	SS-FM12SL12PM12-18	13.4 (34.0)	0.66 (16.0)	1.74 (44.2)

Swagelok Tube Fitting End Connections



Nominal Hose Size in.	Tube Fitting Size in.	Overall Length OAL in. (cm)	Ordering Number	Dimensions		
				Live Length L in. (cm)	Minimum Inside Diameter in. (mm)	Maximum Outside Dimension in. (mm)
1/4	1/4	12.0 (30.5)	SS-FM4SL4SL4-12	8.12 (20.6)	0.19 (4.8)	0.95 (24.1)
		36.0 (91.4)	SS-FM4SL4SL4-36	32.1 (81.5)		
3/8	3/8	18.0 (45.7)	SS-FM6SL6SL6-18	14.0 (35.6)	0.28 (7.1)	1.09 (27.7)
		36.0 (91.4)	SS-FM6SL6SL6-36	32.0 (81.3)		
1/2	1/2	18.0 (45.7)	SS-FM8SL8SL8-18	13.5 (34.3)	0.41 (10.4)	1.23 (31.2)
		48.0 (122)	SS-FM8SL8SL8-48	43.5 (110)		
3/4	3/4	18.0 (45.7)	SS-FM12SL12SL12-18	13.3 (33.8)	0.66 (16.0)	1.74 (44.2)
		48.0 (122)	SS-FM12SL12SL12-48	43.3 (110)		
1	1	24.0 (61.0)	SS-FM16SL16SL16-24	18.7 (47.5)	0.88 (22.4)	2.03 (51.6)

FM Series Metal Hose



Swagelok Tube Adapter End Connections

Nominal Hose Size in.	Tube Adapter Size in.	Overall Length OAL in. (cm)	Ordering Number	Dimensions		
				Live Length L in. (cm)	Minimum Inside Diameter in. (mm)	Maximum Outside Dimension in. (mm)
1/4	1/4	12.0 (30.5)	SS-FM4TA4TA4-12	8.48 (21.5)	0.16 (4.1)	0.75 (19.0)
		24.0 (61.0)	SS-FM4TA4TA4-24	20.5 (52.1)		
		36.0 (91.4)	SS-FM4TA4TA4-36	32.5 (82.6)		
		48.0 (122)	SS-FM4TA4TA4-48	44.5 (113)		

Ordering Information

Custom Hose Assemblies

Build a hose assembly ordering number by combining the designators in the sequence shown below.

Typical Ordering Number

1 2 3 4 4 5 6 5 6
SS - FM 4 TA 4 PM 4 - 28 - F or **71 CM - F**
in. cm

1 Material

End Connections

SS = 316 stainless steel

2 Hose

FM = FM series metal hose

3 Nominal Hose Size, in.

4 = 1/4 16 = 1
 6 = 3/8 20 = 1 1/4
 8 = 1/2 24 = 1 1/2
 12 = 3/4 32 = 2

4 End Connections

See **End Connection Designator** column in tables on next page.

5 Overall Length

Inches or centimeters, in whole numbers. Include **CM** as shown for centimeter lengths.

6 Options

For multiple options, add designators with a dash between each designator.

C = ASTM G93 Level C cleaning on hose wetted surfaces

F = Fire jacket

F1 = Thermosleeve

H7 = Helium leak test (1×10^{-7} std cm³/s)

N3 = Nitrogen pressure test

S = 302 SS spring guard, hose-length (1/4, 3/8, and 1/2 in. sizes only)

W = Hydrostatic test

Mat Tags

MA = Gray **MO** = Orange
MB = Blue **MP** = Purple
MC = Brown **MR** = Red
MG = Green **MW** = White
MK = Black **MY** = Yellow
MN = Pink

Add 2 to the end of the Mat Tag designator for two tags.

Example: MA2

Other Tags

T = Lanyard tag
T2 = Two lanyard tags
T5 = Clamp tag

Specify text for tags. See **Hose Tag Text** table, page 109.

See page 107 for detailed descriptions of options.

FM Series Metal Hose

End Connections

Swagelok Tube Adapters



Cap Weld Style—
1 in. and Under

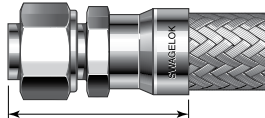

Manual Weld Style—
Over 1 in.

Tube Adapter Size	Nominal Hose Size Designator	End Connection Designator	Dimensions		
			A	Minimum Inside Diameter	Maximum Outside Dimension
Dimensions, in. (mm)					
1/4	4	TA4	1.76 (44.7)	0.16 (4.1)	0.75 (19.0)
3/8	6	TA6	1.82 (46.2)	0.27 (6.9)	0.93 (23.6)
1/2	8	TA8	2.22 (56.4)	0.37 (9.4)	1.05 (26.7)
3/4	12	TA12	2.35 (59.7)	0.58 (14.7)	1.38 (35.1)
1	16	TA16	2.69 (68.3)	0.80 (20.3)	1.69 (42.9)
1 1/4 ^①	20	TA20	4.16 (106)	1.01 (25.7)	2.16 (54.9)
1 1/2 ^①	24	TA24	4.97 (126)	1.24 (31.5)	2.59 (65.8)
2 ^①	32	TA32	5.95 (151)	1.71 (43.4)	3.45 (87.6)
Dimensions, mm (in.)					
6	4	TM6	44.4 (1.75)	4.1 (0.16)	19.0 (0.75)
10	6	TM10	47.0 (1.85)	7.1 (0.28)	23.5 (0.93)
12	8	TM12	57.2 (2.25)	8.9 (0.35)	26.7 (1.05)

① Furnished with nut, preswaged silver-plated front ferrule, and uncoated back ferrule which are required for performance above 450°F (232°C).

Swagelok Tube Fittings

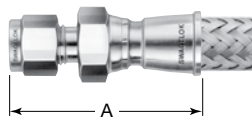

Cap Weld Style—
1 in. and Under



Manual Weld Style—
Over 1 in.

Tube Fitting Size	Nominal Hose Size Designator	End Connection Designator	Dimensions		
			A	Minimum Inside Diameter	Maximum Outside Dimension
Dimensions, in. (mm)					
1/4	4	SL4	1.94 (49.3)	0.19 (4.8)	0.95 (24.1)
3/8	4	SL6	2.00 (50.8)	0.28 (7.1)	0.95 (24.1)
	6	SL6	2.02 (51.3)		1.09 (27.7)
1/2	8	SL8	2.24 (56.9)	0.41 (10.4)	1.23 (31.2)
5/8	8	SL10	2.27 (57.7)	0.50 (12.7)	0.95 (24.1)
3/4	12	SL12	2.35 (59.7)	0.63 (16.0)	1.74 (44.2)
1	16	SL16	2.64 (67.1)	0.88 (22.4)	2.03 (51.6)
1 1/4 ^①	20	SL20	4.04 (103)	1.09 (27.7)	2.23 (58.9)
1 1/2 ^①	24	SL24	4.75 (121)	1.34 (34.0)	2.61 (66.3)
2 ^①	32	SL32	5.72 (145)	1.88 (47.8)	3.48 (88.4)
Dimensions, mm (in.)					
6	4	SM6	30.2 (1.19)	4.8 (0.19)	20.6 (0.81)
8	4	SM8	50.3 (1.98)	6.4 (0.25)	20.6 (0.81)
10	6	SM10	51.6 (2.03)	7.9 (0.31)	27.9 (1.10)
12	8	SM12	59.7 (2.35)	9.7 (0.38)	31.2 (1.23)

① Furnished with silver-plated front ferrule and uncoated back ferrule which are required for performance above 450°F (232°C).

Rotatable Male VCR® Metal Gasket Face Seal Fittings

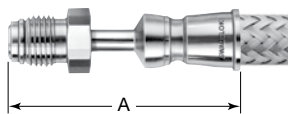

VCR Size in.	Nominal Hose Size Designator	End Connection Designator	Dimensions, in. (mm)		
			A	Minimum Inside Diameter	Maximum Outside Dimension
1/4	4	RM4	2.60 (66.0)	0.18 (4.6)	0.73 (18.4)
1/2	8	RM8	2.83 (71.9)	0.40 (10.2)	1.09 (27.7)
3/4	12	RM12	4.19 (106)	0.65 (16.5)	1.52 (38.7)
1	16	RM16	4.80 (122)	0.87 (22.1)	1.89 (47.9)

FM Series Metal Hose

Rotatable Female VCR Metal Gasket Face Seal Fittings

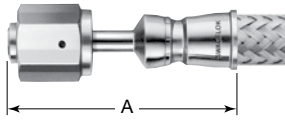

VCR Size in.	Nominal Hose Size Designator	End Connection Designator	Dimensions, in. (mm)		
			A	Minimum Inside Diameter	Maximum Outside Dimension
1/4	4	RF4	2.00 (50.8)	0.18 (4.6)	0.87 (22.1)
1/2	8	RF8	2.16 (54.9)	0.40 (10.2)	1.23 (31.2)
3/4	12	RF12	4.15 (105)	0.65 (16.5)	1.74 (44.2)
1	16	RF16	4.76 (121)	0.87 (22.1)	2.03 (51.6)

Female VCO® O-Ring Face Seal Fittings

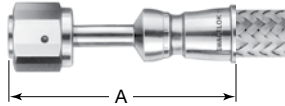

VCO Size in.	Nominal Hose Size Designator	End Connection Designator	Dimensions, in. (mm)		
			A	Minimum Inside Diameter	Maximum Outside Dimension
1/4	4	VF4	2.00 (50.8)	0.18 (4.6)	0.80 (20.3)
1/2	8	VF8	2.14 (54.4)	0.40 (10.2)	1.16 (29.5)

SAE 37° (JIC) Female Swivel

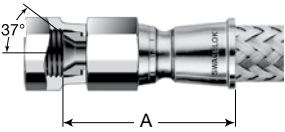

Swivel Size in.	Nominal Hose Size Designator	End Connection Designator	Dimensions, in. (mm)		
			A	Minimum Inside Diameter	Maximum Outside Dimension
1/4	4	AS4	1.53 (38.9)	0.17 (4.3)	0.94 (23.9)
3/8	6	AS6	1.59 (40.4)	0.28 (7.1)	1.09 (27.7)
1/2	8	AS8	1.71 (43.4)	0.42 (10.7)	1.23 (31.2)

Female Pipe Threads, NPT



NPT Size in.	Nominal Hose Size Designator	End Connection Designator	Dimensions, in. (mm)		
			A	Minimum Inside Diameter	Maximum Outside Dimension
1/4	4	PF4	1.81 (46.0)	0.28 (7.1)	0.94 (23.9)
3/8	6	PF6	1.87 (47.5)	0.38 (9.7)	1.09 (27.7)
1/2	8	PF8	2.18 (55.4)	0.47 (11.9)	1.23 (31.2)
3/4	12	PF12	2.21 (56.1)	0.72 (18.3)	1.74 (44.2)

FM Series Metal Hose

Male Pipe Threads,
NPT and ISO/BSP Tapered
(ISO 7)

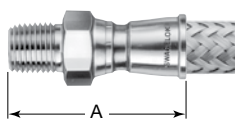

Cap Weld Style—
1 in. and Under

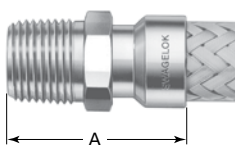

Manual Weld Style—
Over 1 in.

NPT and ISO/BSP Tapered Size in.	Nominal Hose Size Designator	OO Designator	Dimensions, in. (mm)		
			A	Minimum Inside Diameter	Maximum Outside Dimension
NPT					
1/4	4	PM4	1.80 (45.7)	0.28 (7.1)	0.94 (23.9)
	6	PM4	1.81 (46.0)	0.28 (7.1)	1.09 (27.7)
3/8	6	PM6	1.81 (46.0)	0.38 (9.7)	1.09 (27.7)
1/2	4	PM8	1.99 (50.5)	0.47 (11.9)	1.02 (25.8)
	8	PM8	2.15 (54.6)	0.47 (11.9)	1.23 (31.2)
3/4	12	PM12	2.22 (56.4)	0.63 (16.0)	1.74 (44.2)
1	16	PM16	2.54 (64.5)	0.88 (22.4)	2.03 (51.6)
1 1/4	20	PM20	3.06 (77.7)	1.09 (27.7)	2.03 (51.6)
1 1/2	24	PM24	3.72 (94.5)	1.34 (34.0)	2.47 (62.6)
2	32	PM32	4.19 (106)	1.81 (46.0)	3.19 (81.0)
ISO/BSP Tapered					
1/4	4	MT4	1.80 (45.7)	0.28 (7.1)	0.94 (23.9)
1/2	8	MT8	2.16 (54.9)	0.47 (11.9)	1.23 (31.2)

Tube Butt Welds

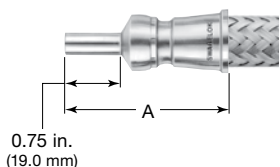

Tube Butt Weld Size in.	Wall Thickness in.	Nominal Hose Size Designator	End Connection Designator	Dimensions, in. (mm)		
				A	Minimum Inside Diameter	Maximum Outside Dimension
1/4	0.035	4	TB4	1.90 (48.3)	0.18 (4.6)	0.75 (19.0)
3/8	0.035	6	TB6	1.89 (48.0)	0.31 (7.9)	0.93 (23.6)
1/2	0.049	8	TB8	2.04 (51.8)	0.40 (10.2)	1.05 (26.7)
3/4	0.049	12	TB12	2.12 (53.8)	0.65 (16.5)	1.38 (35.1)
1	0.065	16	TB16	2.23 (56.6)	0.87 (22.1)	1.69 (42.9)

FJ Series Metal Hose

Features

- General purpose all-metal hose.
- 316L stainless steel annular convoluted core.
- Size range of 1/4 through 2 in. and working pressures from vacuum to 1600 psig (110 bar).
- Single braid layer of 304 stainless steel promotes hose pressure containment.
- End connections welded in accordance with ASME Boiler and Pressure Vessel Code Section IX.
- Optional 316L stainless steel braid available to provide greater corrosion resistance.
- Commonly used in high-temperature vacuum or general purpose applications where permeation is undesirable.
- Custom assemblies available.
- Options include hose covers, hose tags, additional cleaning, and additional helium leak testing. See page 107 for details.
- For electrical properties, see page 5 for details.

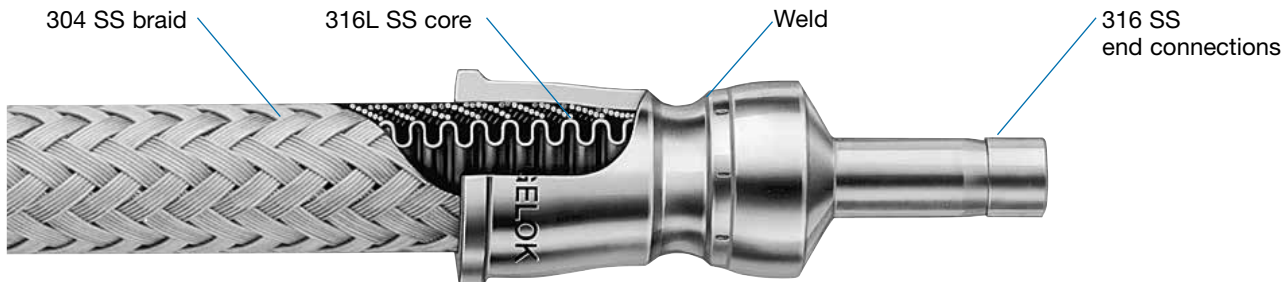

Technical Data

Nominal Hose Size in. (mm)	Inside Diameter in. (mm)	Outside Diameter in. (mm)	Minimum Center Line Bend Radius in. (cm)		Temperature Range °F (°C)	Working Pressure at -325 to 300°F (-200 to 148°C) Vacuum to ... psig (bar)	Minimum Burst Pressure at 70°F (20°C) psig (bar)	Bulk Hose Weight lb/ft (kg/m)
			Static	Dynamic				
1/4 (6.4)	0.25 (6.4)	0.48 (12.2)	1.00 (2.54)	4.33 (11.0)	-325 to 800 (-200 to 426)	1600 (110)	6400 (440)	0.11 (0.16)
3/8 (9.7)	0.38 (9.5)	0.69 (17.5)	1.20 (3.05)	5.91 (15.0)		1470 (101)	5880 (405)	0.20 (0.30)
1/2 (12.7)	0.50 (12.7)	0.82 (20.8)	1.50 (3.81)	6.50 (16.5)		1110 (76.4)	4440 (306)	0.22 (0.33)
3/4 (19.0)	0.75 (19.0)	1.21 (30.7)	2.10 (5.33)	8.86 (22.5)		860 (59.2)	3440 (237)	0.37 (0.55)
1 (25.4)	1.00 (25.4)	1.51 (38.4)	2.70 (6.86)	10.2 (25.9)		680 (46.8)	2720 (187)	0.50 (0.74)
1 1/4 (31.8)	1.25 (31.8)	1.82 (46.2)	3.10 (7.87)	11.8 (30.0)		680 (46.8)	2720 (187)	0.61 (0.91)
1 1/2 (38.1)	1.50 (38.1)	2.14 (54.4)	3.90 (9.91)	13.4 (34.0)		520 (35.8)	2080 (143)	0.85 (1.26)
2 (50.8)	2.00 (50.8)	2.69 (68.3)	5.10 (13.0)	15.4 (39.1)		450 (31.0)	1800 (124)	1.10 (1.65)

Pressure-Temperature Ratings

Ratings are based on ASME Code for Pressure Piping B31.3, Process Piping.

Nominal Hose Size, in.	1/4	3/8	1/2	3/4	1	1 1/4	1 1/2	2
Temperature °F (°C)	Working Pressure, vacuum to ... psig (bar)							
-325 (-200) to 300 (148)	1600 (110)	1470 (101)	1110 (76.4)	860 (59.2)	680 (46.8)	680 (46.8)	520 (35.8)	450 (31.0)
400 (204)	1488 (102)	1367 (94.1)	1032 (71.1)	800 (55.1)	632 (43.5)	632 (43.5)	484 (33.3)	419 (28.8)
500 (260)	1376 (94.8)	1264 (87.0)	955 (65.7)	740 (50.9)	585 (40.3)	585 (40.3)	447 (30.7)	387 (26.6)
600 (315)	1296 (89.2)	1191 (82.0)	899 (61.9)	697 (48.0)	551 (37.9)	551 (37.9)	421 (29.0)	365 (25.1)
700 (371)	1232 (84.8)	1132 (77.9)	855 (58.9)	662 (45.6)	524 (36.1)	524 (36.1)	400 (27.5)	347 (23.9)
750 (398)	1200 (82.6)	1103 (75.9)	833 (57.3)	645 (44.4)	510 (35.1)	510 (35.1)	390 (26.8)	338 (23.2)
800 (426)	1184 (81.5)	1088 (74.9)	821 (56.5)	636 (43.8)	503 (34.6)	503 (34.6)	385 (26.5)	333 (22.9)

FJ Series Metal Hose

Testing

Every Swagelok FJ series hose assembly is inboard helium leak tested to a maximum leak rate of 1×10^{-5} std cm³/s.

For additional testing, see **Testing**, page 108.

Cleaning and Packaging

Swagelok FJ series hose components are cleaned in accordance with Swagelok *Standard Cleaning and Packaging (SC-10)* catalog, [MS-06-62](#). Each hose is bagged individually and boxed; longer hoses are coiled, bagged, and boxed.

⚠ Do not subject flexible metal hose to pressure surges, shock, or pulsations, where the peak pressure is greater than 50 % of the working pressure rating.

Ordering Information

Custom Hose Assemblies

Build a hose assembly ordering number by combining the designators in the sequence shown below.

Typical Ordering Number

1 2 3 4 4 5 6 5 6
 SS - FJ 4 TA4 PM4 - 28 - F or 71CM - F
└── in. ──┘ └── cm ──┘

1 Material

End Connections

SS = 316 stainless steel

2 Hose

FJ = FJ series metal hose

3 Nominal Hose Size, in.

4 = 1/4	16 = 1
6 = 3/8	20 = 1 1/4
8 = 1/2	24 = 1 1/2
12 = 3/4	32 = 2

4 End Connections

See **End Connection Designator** column in tables on next page.

5 Overall Length

Inches or centimeters, in whole numbers. Include **CM** as shown for centimeter lengths.

6 Options

For multiple options, add designators with a dash between each designator.

A = Armor guard
F = Fire jacket
C = ASTM G93 Level C cleaning on hose wetted surfaces
G = CGA 4.1 cleaning on hose wetted surfaces
F1 = Thermosleeve
H7 = Helium leak test (1×10^{-7} std cm³/s)
N3 = Nitrogen pressure test
W = Hydrostatic test
Z = 316L SS braid material
093 = ECE R110 approval, only on select end connections. See page 110 for additional information.

Mat Tags

MA = Gray	MO = Orange
MB = Blue	MP = Purple
MC = Brown	MR = Red
MG = Green	MW = White
MK = Black	MY = Yellow
MN = Pink	

Add **2** to the end of the Mat Tag designator for two tags.

Example: MA2

Other Tags

T = Lanyard tag
T2 = Two lanyard tags
T5 = Clamp tag

Specify text for tags. See **Hose Tag Text** table, page 109.

See page 107 for detailed descriptions of options.

FJ Series Metal Hose

End Connections

Swagelok Tube Adapters



Cap Weld Style—
1/4 and 1/2 in.

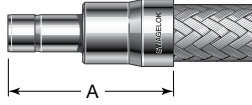

Manual Weld Style—
1 in. and Under

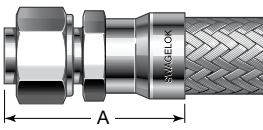

Manual Weld Style—
Preswaged
Nuts and Ferrules—
Over 1 in. / 25 mm

Tube Adapter Size	Nominal Hose Size Designator	End Connection Designator	Dimensions		
			A	Minimum Inside Diameter	Maximum Outside Dimension
Dimensions, in. (mm)					
1/4	4	TA4	1.85 (47.0)	0.18 (4.6)	0.76 (19.2)
3/8	6	TA6	1.81 (46.0)	0.27 (6.9)	0.78 (19.8)
1/2	8	TA8 ^②	2.32 (58.9)	0.37 (9.4)	1.05 (26.7)
3/4	12	TA12 ^②	2.50 (63.5)	0.58 (14.7)	1.32 (33.5)
1	16	TA16	2.99 (75.9)	0.80 (20.3)	1.63 (41.4)
1 1/4 ^①	20	TA20	3.91 (99.3)	1.02 (25.9)	2.18 (55.2)
1 1/2 ^①	24	TA24	4.47 (114)	1.25 (31.8)	2.61 (66.3)
2 ^①	32	TA32	5.45 (138)	1.72 (43.7)	3.48 (88.4)
Dimensions, mm (in.)					
6	4	TM6	47.2 (1.86)	4.1 (0.16)	13.7 (0.54)
8	4	TM8	47.5 (1.87)	5.6 (0.22)	13.7 (0.54)
10	6	TM10	53.3 (2.10)	7.1 (0.28)	19.8 (0.78)
12	8	TM12 ^②	59.2 (2.33)	8.9 (0.35)	25.5 (1.00)
18	12	TM18 ^②	61.0 (2.40)	14.0 (0.55)	33.5 (1.32)
25	16	TM25	75.9 (2.99)	19.8 (0.78)	41.4 (1.63)
32 ^①	20	TM32	87.4 (3.44)	26.4 (1.04)	58.0 (2.28)
38 ^①	24	TM38	97.3 (3.83)	31.8 (1.25)	69.6 (2.74)

① Furnished with nut, preswaged silver-plated front ferrule, and uncoated back ferrule which are required for performance above 450°F (232°C).

② ECE R110 approval available.

Swagelok Tube Fittings

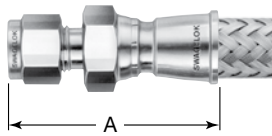

Cap Weld Style—
1/4 and 1/2 in.

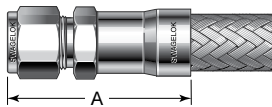

Manual Weld Style—
All other sizes

Tube Fitting Size	Nominal Hose Size Designator	End Connection Designator	Dimensions		
			A	Minimum Inside Diameter	Maximum Outside Dimension
Dimensions, in. (mm)					
1/4	4	SL4	2.08 (52.8)	0.19 (4.8)	0.94 (23.8)
3/8	6	SL6	2.07 (52.6)	0.28 (7.1)	0.80 (20.3)
1/2	8	SL8	2.28 (57.9)	0.41 (10.4)	1.23 (31.2)
3/4	12	SL12	2.62 (66.6)	0.63 (16.0)	1.32 (33.5)
1	16	SL16	3.20 (81.3)	0.88 (22.4)	1.63 (41.4)
1 1/4 ^①	20	SL20	3.79 (96.3)	1.09 (27.7)	2.03 (51.6)
1 1/2 ^①	24	SL24	4.25 (108)	1.35 (34.3)	2.47 (65.6)
2 ^①	32	SL32	5.22 (133)	1.82 (46.2)	3.19 (81.0)
Dimensions, mm (in.)					
6	4	SM6	47.5 (1.87)	4.8 (0.19)	16.2 (0.64)
8	4	SM8	48.3 (1.90)	6.4 (0.25)	17.4 (0.69)
10	6	SM10	53.3 (2.10)	7.9 (0.31)	20.9 (0.82)
12	8	SM12	61.7 (2.43)	9.7 (0.38)	25.5 (1.00)
18	12	SM18	66.5 (2.62)	15.0 (0.59)	31.2 (1.23)
25	16	SM25	81.3 (3.20)	21.8 (0.86)	40.5 (1.60)
32 ^①	20	SM32	97.8 (3.85)	28.7 (1.13)	53.4 (2.10)
38 ^①	24	SM38	111 (4.36)	33.8 (1.33)	63.8 (2.51)

① Furnished with silver-plated front ferrule and uncoated back ferrule which are required for performance above 450°F (232°C).

FJ Series Metal Hose

Rotatable Male VCR Metal Gasket Face Seal Fittings

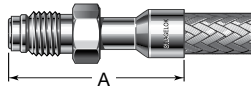

VCR Size in.	Nominal Hose Size Designator	End Connection Designator	Dimensions, in. (mm)		
			A	Minimum Inside Diameter	Maximum Outside Dimension
1/4	4	RM4	1.69 (42.9)	0.18 (4.6)	0.73 (18.4)
1/2	8	RM8	2.00 (50.8)	0.40 (10.2)	1.09 (27.7)
3/4	12	RM12	2.63 (66.8)	0.63 (16.0)	1.52 (38.7)
1	16	RM16	2.97 (75.4)	0.88 (22.4)	1.89 (47.9)

Rotatable Female VCR Metal Gasket Face Seal Fittings

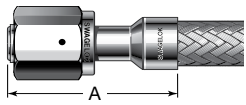

VCR Size in.	Nominal Hose Size Designator	End Connection Designator	Dimensions, in. (mm)		
			A	Minimum Inside Diameter	Maximum Outside Dimension
1/4	4	RF4	1.69 (42.9)	0.18 (4.6)	0.87 (22.1)
1/2	8	RF8	2.00 (50.8)	0.40 (10.2)	1.23 (31.2)
3/4	12	RF12	2.63 (66.8)	0.63 (16.0)	1.74 (44.2)
1	16	RF16	2.97 (75.4)	0.88 (22.4)	2.03 (51.6)

Female VCO O-Ring Face Seal Fittings

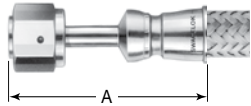

Cap Weld Style—
1/4 and 1/2 in.

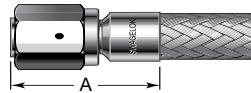

Manual Weld Style—
All other sizes

VCO Size in.	Nominal Hose Size Designator	End Connection Designator	Dimensions, in. (mm)		
			A	Minimum Inside Diameter	Maximum Outside Dimension
1/4	4	VF4	1.15 (29.2)	0.19 (4.8)	0.80 (20.3)
1/2	8	VF8	1.31 (33.3)	0.41 (10.4)	1.16 (29.5)
3/4	12	VF12	1.57 (39.9)	0.63 (16.0)	1.74 (44.2)
1	16	VF16	1.73 (43.9)	0.88 (22.4)	2.03 (51.6)

SAE 37° (JIC) Female Swivel



Cap Weld Style—
1/4 and 1/2 in.



Manual Weld Style—
All other sizes

Swivel Size in.	Nominal Hose Size Designator	End Connection Designator	Dimensions, in. (mm)		
			A	Minimum Inside Diameter	Maximum Outside Dimension
1/4	4	AS4	1.67 (42.4)	0.19 (4.8)	0.94 (23.8)
3/8	6	AS6	1.41 (35.8)	0.28 (7.1)	0.80 (20.3)
1/2	8	AS8	1.77 (45.0)	0.39 (9.9)	1.23 (31.2)
3/4	12	AS12	1.76 (44.7)	0.61 (15.5)	1.45 (36.8)
1	16	AS16	2.08 (52.8)	0.84 (21.3)	1.74 (44.2)

FJ Series Metal Hose

Female Pipe Threads, NPT



Cap Weld Style—
1/4 and 1/2 in.

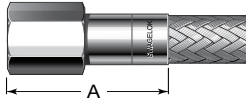

Manual Weld Style—
All other sizes

NPT Size in.	Nominal Hose Size Designator	End Connection Designator	Dimensions, in. (mm)		
			A	Minimum Inside Diameter	Maximum Outside Dimension
1/4	4	PF4	1.74 (44.2)	0.30 (7.6)	0.94 (23.8)
3/8	6	PF6	1.84 (46.7)	0.42 (10.7)	1.02 (25.8)
1/2	8	PF8	2.11 (53.6)	0.58 (14.7)	1.23 (31.2)
3/4	12	PF12	2.41 (61.2)	0.73 (18.5)	1.52 (38.7)
1	16	PF16	2.92 (74.2)	0.95 (24.1)	1.89 (47.9)
1 1/2	24	PF24	3.28 (83.3)	1.50 (38.1)	2.76 (70.0)

Male Pipe Threads, NPT and ISO/BSP Tapered (ISO 7)



Cap Weld Style—
1/4 and 1/2 in.

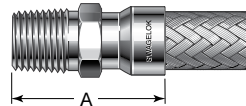

Manual Weld Style—
All other sizes

NPT and ISO/BSP Tapered Size in.	Nominal Hose Size Designator	End Connection Designator	Dimensions, in. (mm)		
			A	Minimum Inside Diameter	Maximum Outside Dimension
NPT					
1/4	4	PM4	1.94 (49.3)	0.28 (7.1)	0.94 (23.8)
3/8	6	PM6	1.91 (48.5)	0.38 (9.7)	0.80 (20.3)
1/2	8	PM8	2.32 (58.9)	0.47 (11.9)	1.23 (31.2)
3/4	12	PM12	2.45 (62.2)	0.63 (16.0)	1.32 (33.5)
1	16	PM16	3.05 (77.5)	0.88 (22.4)	1.63 (41.4)
1 1/4	20	PM20	3.14 (79.8)	1.09 (27.7)	2.03 (51.6)
1 1/2	24	PM24	3.38 (85.9)	1.34 (34.0)	2.47 (62.6)
2	32	PM32	3.63 (92.2)	1.81 (46.0)	2.76 (70.0)
ISO/BSP Tapered					
1/4	4	MT4	1.94 (49.3)	0.28 (7.1)	0.94 (23.8)
3/8	6	MT6	1.91 (48.5)	0.38 (9.7)	0.80 (20.3)
1/2	8	MT8	2.32 (58.9)	0.47 (11.9)	1.23 (31.2)
3/4	12	MT12	2.45 (62.2)	0.63 (16.0)	1.32 (33.5)
1	16	MT16	3.05 (77.5)	0.88 (22.4)	1.63 (41.4)
1 1/4	20	MT20	3.14 (79.8)	1.09 (27.7)	2.03 (51.6)
1 1/2	24	MT24	3.38 (85.9)	1.34 (34.0)	2.47 (62.6)

Tube Butt Welds

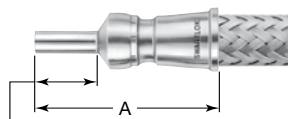

0.75 in.
(19.0 mm)

Cap Weld Style—
1/4 and 1/2 in.

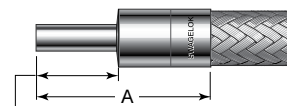

0.75 in.
(19.0 mm)

Manual Weld Style—
All other sizes

Tube Butt Weld Size in.	Wall Thickness in.	Nominal Hose Size Designator	End Connection Designator	Dimensions, in. (mm)		
				A	Minimum Inside Diameter	Maximum Outside Dimension
1/4	0.035	4	TB4	1.99 (50.5)	0.18 (4.6)	0.76 (19.2)
3/8	0.035	6	TB6	1.82 (46.2)	0.31 (7.9)	0.78 (19.8)
1/2	0.049	8	TB8	2.14 (54.4)	0.40 (10.2)	1.05 (26.7)
3/4	0.049	12	TB12	2.14 (54.4)	0.65 (16.5)	1.32 (33.5)
1	0.065	16	TB16	2.46 (62.5)	0.87 (22.1)	1.63 (41.4)

FL Series Metal Hose

Features

- Highly flexible all-metal hose.
- 316L stainless steel annular convoluted core.
- Size range of 1/4 through 2 in. sizes and working pressures from vacuum to 1500 psig (103 bar).
- Single braid layer of 321 stainless steel for sizes 1/4 and 1/2 in. and 316L stainless steel for all other sizes ensures hose pressure containment.
- End connections welded in accordance with ASME Boiler and Pressure Vessel Code Section IX.
- Exhibits strong performance in dynamic cycling applications.
- Commonly used in high-temperature vacuum and general purpose dynamic-cycling applications.
- Standard and custom assemblies available.
- Options include hose covers, hose tags, additional cleaning, and additional helium leak testing. See page 107 for details.
- For electrical properties, see page 5 for details.

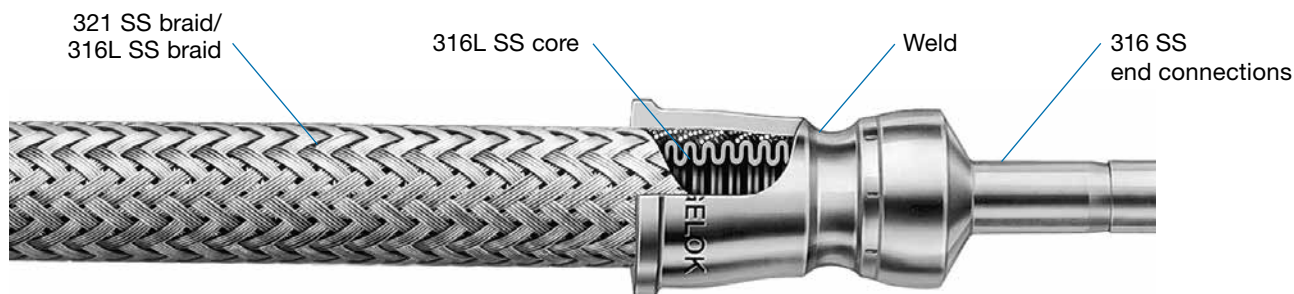

Technical Data

Nominal Hose Size in. (mm)	Inside Diameter in. (mm)	Outside Diameter in. (mm)	Minimum Center Line Bend Radius in. (cm)		Temperature Range °F (°C)	Working Pressure at -325 to 100°F (-200 to 37°C) Vacuum to ... psig (bar)	Minimum Burst Pressure at 70°F (20°C) psig (bar)	Bulk Hose Weight lb/ft (kg/m)
			Static	Dynamic				
1/4 (6.4)	0.25 (6.4)	0.45 (11.4)	1.00 (2.54)	5.50 (14.0)	-325 to 850 (-200 to 454)	1500 (103)	6000 (413)	0.12 (0.18)
3/8 (9.5)	0.38 (9.5)	0.70 (17.8)	1.00 (2.54)	4.00 (10.2)		1470 (101)	5880 (405)	0.21 (0.31)
1/2 (12.7)	0.50 (12.7)	0.81 (20.6)	1.75 (4.45)	7.00 (17.8)		1200 (82.6)	4800 (330)	0.24 (0.36)
3/4 (19.0)	0.75 (19.0)	1.22 (31.0)	1.70 (4.32)	6.40 (16.3)		860 (59.3)	3440 (237)	0.47 (0.70)
1 (25.4)	1.00 (25.4)	1.54 (39.1)	2.10 (5.33)	7.10 (18.0)		680 (46.8)	2720 (187)	0.64 (0.96)
1 1/4 (31.8)	1.25 (31.8)	1.84 (46.7)	2.50 (6.35)	7.90 (20.1)		645 (44.4)	2580 (178)	0.99 (1.48)
1 1/2 (38.1)	1.50 (38.1)	2.16 (54.9)	3.10 (7.87)	11.0 (27.9)		520 (35.8)	2080 (143)	1.16 (1.74)
2 (50.8)	2.00 (50.8)	2.69 (68.3)	4.00 (10.2)	13.0 (33.0)		380 (26.2)	1520 (105)	1.48 (2.22)

Pressure-Temperature Ratings

Ratings are based on ASME Code for Pressure Piping, B31.1 Power Piping, and ASME Boiler and Pressure Vessel Code.

Nominal Hose Size, in.	1/4	3/8	1/2	3/4	1	1 1/4	1 1/2	2
Temperature °F (°C)	Working Pressure Vacuum to ... psig (bar)							
-325 (-200) to 100 (37)	1500 (103)	1470 (101)	1200 (82.7)	860 (59.2)	680 (46.8)	645 (44.4)	520 (35.8)	380 (26.1)
200 (93)	1260 (86.8)	1235 (85.0)	1008 (69.4)	722 (49.7)	571 (39.3)	542 (37.3)	437 (30.1)	319 (21.9)
300 (148)	1140 (78.5)	1117 (76.9)	912 (62.8)	654 (45.0)	517 (35.6)	490 (33.7)	395 (27.2)	289 (19.9)
400 (204)	1050 (72.3)	1029 (70.8)	840 (57.9)	602 (41.4)	476 (32.7)	451 (31.0)	364 (25.0)	266 (18.3)
500 (260)	975 (67.2)	955 (65.7)	780 (53.7)	559 (38.5)	442 (30.4)	419 (28.8)	338 (23.2)	247 (17.0)
600 (315)	930 (64.1)	911 (62.7)	744 (51.2)	533 (36.7)	422 (29.0)	400 (27.5)	322 (22.1)	236 (16.2)
700 (371)	885 (61.0)	867 (59.7)	708 (48.8)	507 (34.9)	401 (27.6)	381 (26.2)	307 (21.1)	224 (15.4)
750 (398)	870 (59.9)	853 (58.7)	696 (47.9)	499 (34.3)	394 (27.1)	374 (25.7)	302 (20.8)	220 (15.1)
800 (426)	855 (58.9)	838 (57.7)	684 (47.1)	490 (33.7)	388 (26.7)	368 (25.3)	296 (20.3)	216 (14.8)
850 (454)	840 (57.9)	823 (56.7)	672 (46.3)	482 (33.2)	381 (26.2)	361 (24.8)	291 (20.0)	213 (14.6)

FL Series Metal Hose

Testing

Every Swagelok FL series hose assembly is inboard helium leak tested to a maximum leak rate of 1×10^{-5} std cm³/s.

For additional testing, see **Testing**, page 108.

Cleaning and Packaging

Swagelok FL series hose components are cleaned in accordance with Swagelok *Standard Cleaning and Packaging (SC-10)* catalog, [MS-06-62](#).

Each hose is bagged individually and boxed; longer hoses are coiled, bagged, and boxed.

⚠ Do not subject flexible metal hose to pressure surges, shock, or pulsations, where the peak pressure is greater than 50 % of the working pressure rating.

Ordering Information and Dimensions

Standard Length Hose Assemblies

Select an ordering number.

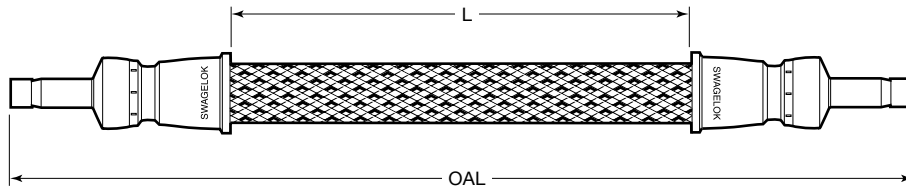

Swagelok Tube Adapter End Connections



Nominal Hose Size	Tube Adapter Size	Overall Length OAL	Ordering Number	Dimensions		
				Live Length L	Minimum Inside Diameter	Maximum Outside Dimension
Dimensions, in.		in. (cm)		in. (cm)	in. (mm)	
1/4	1/4	12.0 (30.5)	SS-FL4TA4TA4-12	8.48 (21.5)	0.16 (4.1)	0.66 (16.8)
		24.0 (61.0)	SS-FL4TA4TA4-24	20.5 (52.1)		
		36.0 (91.4)	SS-FL4TA4TA4-36	32.5 (82.6)		
		48.0 (122)	SS-FL4TA4TA4-48	44.5 (113)		
1/2	1/2	12.0 (30.5)	SS-FL8TA8TA8-12	7.50 (19.0)	0.37 (9.4)	1.01 (25.7)
		24.0 (61.0)	SS-FL8TA8TA8-24	19.5 (49.5)		
		36.0 (91.4)	SS-FL8TA8TA8-36	31.5 (80.0)		

FL Series Metal Hose

Ordering Information

Custom Hose Assemblies

Build a hose assembly ordering number by combining the designators in the sequence shown below.

Typical Ordering Number

1 2 3 4 4 5 6 5 6
SS - FL 4 TA4 PM4 - 28 - F or **71CM - F**
in. cm

1 Material

End Connections

SS = 316 stainless steel

2 Hose

FL = FL series metal hose

3 Nominal Hose Size, in.

4 = 1/4	16 = 1
6 = 3/8	20 = 1 1/4
8 = 1/2	24 = 1 1/2
12 = 3/4	32 = 2

4 End Connections

See **End Connection Designator** column in tables below.

5 Overall Length

Inches or centimeters, in whole numbers. Include **CM** as shown for centimeter lengths.

6 Options

For multiple options, add designators with a dash between each designator.

F = Fire jacket

F1 = Thermosleeve

C = ASTM G93 Level C cleaning on hose wetted surfaces

G = CGA 4.1 cleaning on hose wetted surfaces

H7 = Helium leak test (1×10^{-7} std cm³/s)

N3 = Nitrogen pressure test

W = Hydrostatic test

Mat Tags

MA = Gray

MO = Orange

MB = Blue

MP = Purple

MC = Brown

MR = Red

MG = Green

MW = White

MK = Black

MY = Yellow

MN = Pink

Add 2 to the end of the Mat Tag designator for two tags.

Example: MA2

Other Tags

T = Lanyard tag

T2 = Two lanyard tags

Specify text for tags. See **Hose Tag Text** table, page 109.

See page 107 for detailed descriptions of options.

FL Series Metal Hose

End Connections

Swagelok Tube Adapters



Cap Weld Style—
1/4 and 1/2 in.

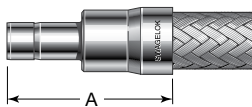

Manual Weld Style—
3/8, 3/4, and 1 in.

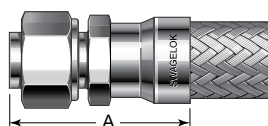

Manual Weld Style—
Preswaged
Nuts and Ferrules—
Over 1 in. / 25 mm

Tube Adapter Size	Nominal Hose Size Designator	End Connection Designator	A	Minimum Inside Diameter	Maximum Outside Dimension
Dimensions, in. (mm)					
1/4	4	TA4	1.76 (44.7)	0.16 (4.1)	0.66 (16.8)
3/8	4	TA6	1.79 (45.5)	0.27 (6.9)	0.66 (16.8)
	6	TA6	1.81 (46.0)		0.83 (21.1)
	8	TA6	2.03 (51.6)		1.01 (25.7)
1/2	8	TA8	2.25 (57.2)	0.37 (9.4)	1.01 (25.7)
3/4	12	TA12	2.50 (63.5)	0.58 (14.7)	1.39 (35.3)
1	16	TA16	2.87 (72.9)	0.80 (20.3)	1.66 (42.2)
1 1/4 ^①	20	TA20	3.91 (99.3)	1.02 (25.9)	2.16 (54.9)
1 1/2 ^①	24	TA24	4.47 (113)	1.25 (31.8)	2.59 (65.8)
2 ^①	32	TA32	5.45 (138)	1.72 (43.7)	3.45 (87.6)
Dimensions, mm (in.)					
6	4	TM6	44.4 (1.75)	4.1 (0.16)	16.8 (0.66)
8	4	TM8	45.2 (1.78)	5.6 (0.22)	16.8 (0.66)
10	4	TM10	45.2 (1.78)	7.1 (0.28)	16.8 (0.66)
	6	TM10	53.3 (2.10)		25.7 (1.01)
	8	TM10	51.3 (2.02)		25.7 (1.01)
12	8	TM12	57.4 (2.26)	8.9 (0.35)	25.7 (1.01)
18	12	TM18	61.0 (2.40)	14.0 (0.55)	35.3 (1.39)
25	16	TM25	72.9 (2.87)	19.8 (0.78)	42.2 (1.66)
32 ^①	20	TM32	87.4 (3.44)	26.4 (1.04)	57.4 (2.26)
38 ^①	24	TM38	97.3 (3.83)	31.8 (1.25)	69.1 (2.72)

① Furnished with nut, preswaged silver-plated front ferrule, and uncoated back ferrule which are required for performance above 450°F (232°C).

Swagelok Tube Fittings

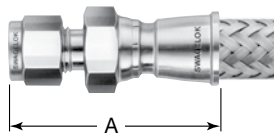

Cap Weld Style—
1/4 and 1/2 in.

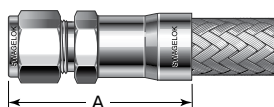

Manual Weld Style—
All other sizes

Tube Fitting Size	Nominal Hose Size Designator	End Connection Designator	A	Minimum Inside Diameter	Maximum Outside Dimension
Dimensions, in. (mm)					
1/4	4	SL4	1.94 (49.3)	0.19 (4.8)	0.80 (20.3)
3/8	6	SL6	2.07 (52.6)	0.28 (7.1)	0.83 (21.1)
	8	SL6	2.22 (56.4)	0.28 (7.1)	1.23 (31.2)
1/2	8	SL8	2.33 (59.2)	0.41 (10.4)	1.23 (31.2)
3/4	12	SL12	2.62 (66.5)	0.63 (16.0)	1.39 (35.3)
1	16	SL16	3.08 (78.2)	0.88 (22.4)	1.66 (42.2)
1 1/4 ^①	20	SL20	3.79 (96.3)	1.09 (27.7)	2.02 (51.3)
1 1/2 ^①	24	SL24	4.25 (108)	1.35 (34.3)	2.45 (62.2)
2 ^①	32	SL32	5.22 (133)	1.82 (46.2)	3.17 (80.5)
Dimensions, mm (in.)					
6	4	SM6	49.3 (1.94)	4.8 (0.19)	20.3 (0.80)
10	6	SM10	53.6 (2.11)	7.9 (0.31)	21.1 (0.83)
	8	SM10	56.4 (2.22)	7.9 (0.31)	31.2 (1.23)
12	8	SM12	59.2 (2.33)	9.7 (0.38)	31.2 (1.23)
18	12	SM18	66.5 (2.62)	15.0 (0.59)	35.3 (1.39)
25	16	SM25	78.2 (3.08)	21.8 (0.86)	42.2 (1.66)
32 ^①	20	SM32	98.8 (3.89)	28.7 (1.13)	52.8 (2.08)
38 ^①	24	SM38	111 (4.36)	33.8 (1.33)	63.2 (2.49)

① Furnished with silver-plated front ferrule, and uncoated back ferrule which are required for performance above 450°F (232°C).

See next page for more end connections.

FL Series Metal Hose

Rotatable Male VCR Metal Gasket Face Seal Fittings

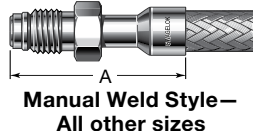
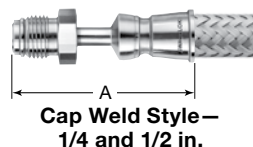

VCR Size in.	Nominal Hose Size Designator	End Connection Designator	Dimensions, in. (mm)		
			A	Minimum Inside Diameter	Maximum Outside Dimension
1/4	4	RM4	2.60 (66.0)	0.18 (4.6)	0.73 (18.4)
1/2	8	RM8	2.88 (73.2)	0.40 (10.2)	1.09 (27.7)
3/4	12	RM12	2.63 (66.8)	0.63 (16.0)	1.51 (38.4)
1	16	RM16	2.85 (72.4)	0.88 (22.4)	1.88 (47.8)

Rotatable Female VCR Metal Gasket Face Seal Fittings

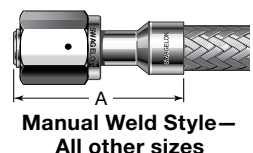
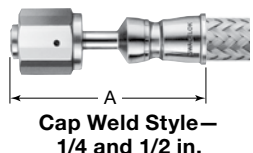

VCR Size in.	Nominal Hose Size Designator	End Connection Designator	Dimensions, in. (mm)		
			A	Minimum Inside Diameter	Maximum Outside Dimension
1/4	4	RF4	2.00 (50.8)	0.18 (4.6)	0.87 (22.1)
1/2	8	RF8	2.21 (56.1)	0.40 (10.2)	1.23 (31.2)
3/4	12	RF12	2.63 (66.8)	0.63 (16.0)	1.73 (43.9)
1	16	RF16	2.85 (72.4)	0.88 (22.4)	2.02 (51.3)

Female VCO O-Ring Face Seal Fittings

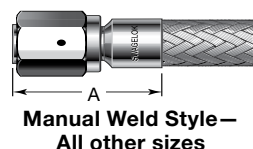
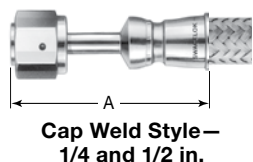

VCO Size in.	Nominal Hose Size Designator	End Connection Designator	Dimensions, in. (mm)		
			A	Minimum Inside Diameter	Maximum Outside Dimension
1/4	4	VF4	2.48 (63.0)	0.18 (4.6)	0.80 (20.3)
1/2	8	VF8	2.69 (68.3)	0.40 (10.2)	1.16 (29.5)
3/4	12	VF12	1.57 (39.9)	0.63 (16.0)	1.73 (43.9)
1	16	VF16	1.61 (40.9)	0.88 (22.4)	2.02 (51.3)

SAE 37° (JIC) Female Swivel

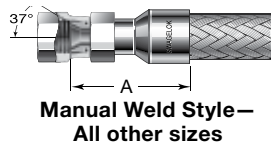

Swivel Size in.	Nominal Hose Size Designator	End Connection Designator	Dimensions, in. (mm)		
			A	Minimum Inside Diameter	Maximum Outside Dimension
1/4	4	AS4	1.53 (38.9)	0.17 (4.3)	0.79 (20.1)
3/8	6	AS6	1.46 (37.1)	0.28 (7.1)	0.87 (22.1)
1/2	8	AS8	1.77 (45.0)	0.42 (10.7)	1.23 (31.2)
3/4	12	AS12	1.76 (44.7)	0.61 (15.5)	1.44 (36.6)
1	16	AS16	2.08 (52.8)	0.84 (21.3)	1.73 (43.9)

FL Series Metal Hose

Female Pipe Threads, NPT



Cap Weld Style—
1/4 and 1/2 in.

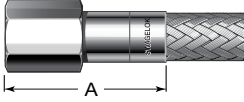

Manual Weld Style—
All other sizes

NPT Size in.	Nominal Hose Size Designator	End Connection Designator	Dimensions, in. (mm)		
			A	Minimum Inside Diameter	Maximum Outside Dimension
1/4	4	PF4	1.81 (46.0)	0.28 (7.1)	0.87 (22.1)
3/8	6	PF6	1.84 (46.7)	0.42 (10.7)	1.01 (25.7)
1/2	8	PF8	2.22 (56.4)	0.47 (11.9)	1.23 (31.2)
3/4	12	PF12	2.41 (61.2)	0.73 (18.5)	1.51 (38.4)
1	16	PF16	2.80 (71.1)	0.95 (24.1)	1.88 (47.8)
1 1/2	24	PF24	3.28 (83.3)	1.50 (38.1)	2.74 (69.6)

Male Pipe Threads, NPT and ISO/BSP Tapered (ISO 7)



Cap Weld Style—
1/4 and 1/2 in.

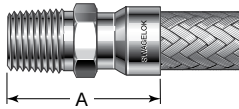

Manual Weld Style—
All other sizes

NPT and ISO/BSP Tapered Size in.	Nominal Hose Size Designator	End Connection Designator	Dimensions, in. (mm)		
			A	Minimum Inside Diameter	Maximum Outside Dimension
NPT					
1/4	4	PM4	1.80 (45.7)	0.28 (7.1)	0.80 (20.3)
3/8	6	PM6	1.91 (48.5)	0.38 (9.7)	0.83 (21.1)
	8	PM6	2.02 (51.3)		1.23 (31.2)
1/2	8	PM8	2.21 (56.1)	0.47 (11.9)	1.23 (31.2)
3/4	12	PM12	2.45 (62.2)	0.63 (16.0)	1.39 (35.3)
1	16	PM16	2.93 (74.4)	0.88 (22.4)	1.66 (42.2)
1 1/4	20	PM20	3.14 (79.8)	1.09 (27.7)	2.02 (51.3)
1 1/2	24	PM24	3.38 (85.9)	1.34 (34.0)	2.45 (62.2)
2	32	PM32	3.63 (92.2)	1.81 (46.0)	2.81 (71.4)
ISO/BSP Tapered					
1/4	4	MT4	1.80 (45.7)	0.28 (7.1)	0.80 (20.3)
3/8	6	MT6	1.91 (48.5)	0.38 (9.7)	0.83 (21.1)
1/2	8	MT8	2.21 (56.1)	0.47 (11.9)	1.23 (31.2)
3/4	12	MT12	2.45 (62.2)	0.63 (16.0)	1.39 (35.3)
1	16	MT16	2.93 (74.4)	0.88 (22.4)	1.66 (42.2)
1 1/4	20	MT20	3.14 (79.8)	1.09 (27.7)	2.02 (51.3)
1 1/2	24	MT24	3.38 (85.8)	1.34 (34.0)	2.45 (62.2)

Tube Butt Welds

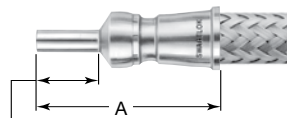

0.75 in.
(19.0 mm)

Cap Weld Style—
1/4 and 1/2 in.

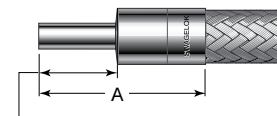

0.75 in.
(19.0 mm)

Manual Weld Style—
All other sizes

Tube Butt Weld Size in.	Wall Thickness in.	Nominal Hose Size Designator	End Connection Designator	Dimensions, in. (mm)		
				A	Minimum Inside Diameter	Maximum Outside Dimension
1/4	0.035	4	TB4	1.90 (48.3)	0.18 (4.6)	0.66 (16.8)
3/8	0.035	6	TB6	1.82 (46.2)	0.31 (7.9)	0.83 (21.1)
1/2	0.049	8	TB8	2.09 (53.1)	0.40 (10.2)	1.01 (25.7)
3/4	0.049	12	TB12	2.14 (54.4)	0.65 (16.5)	1.39 (35.3)

AH Series Metal Hose

Features

- Corrosion resistant all-metal hose.
- Alloy C-276 annular convoluted core.
- Size range of 1/2 through 2 in. and working pressures from vacuum to 1110 psig (76.4 bar).
- Single braid layer of 316L stainless steel promotes hose pressure containment.
- End connections welded in accordance with ASME Boiler and Pressure Vessel Code Section IX.
- Commonly used in high-temperature vacuum or corrosion resistant applications where permeation is undesirable.
- Custom assemblies available.
- Options include hose covers, hose tags, additional cleaning, and additional helium leak testing. See page 108 for details.
- C-276 braid and end connections available upon request.

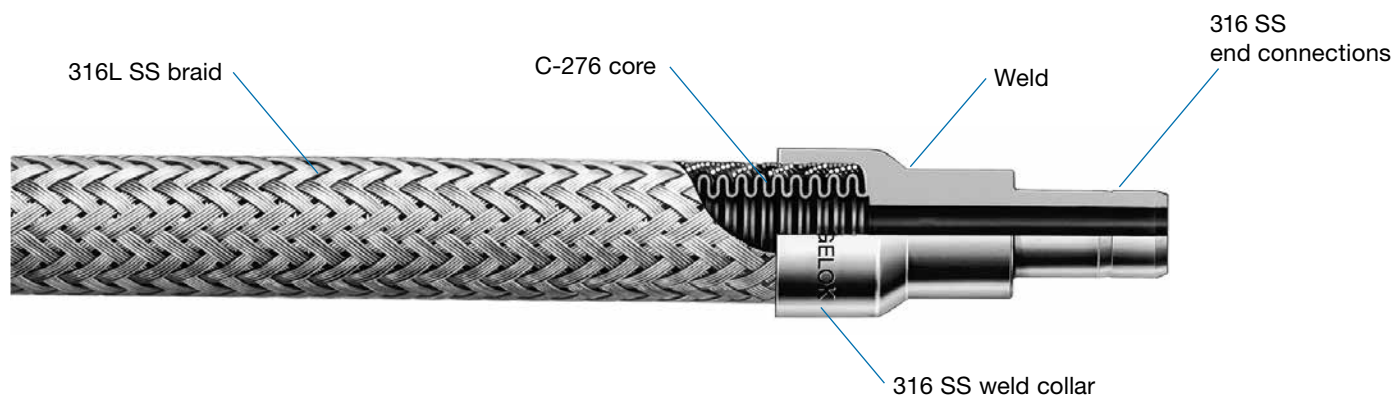

Technical Data

Nominal Hose Size in. (mm)	Inside Diameter in. (mm)	Outside Diameter in. (mm)	Minimum Center Line Bend Radius in. (cm)		Temperature Range °F (°C)	Working Pressure at -325 to 300°F (-200 to 148°C) Vacuum to ... psig (bar)	Minimum Burst Pressure at 70°F (20°C) psig (bar)	Bulk Hose Weight lb/ft (kg/m)
			Static	Dynamic				
1/2 (12.7)	0.50 (12.7)	0.82 (20.8)	1.50 (3.81)	6.50 (16.5)	-325 to 800 (-200 to 426)	1110 (76.4)	4440 (306)	0.22 (0.33)
3/4 (19.0)	0.75 (19.0)	1.21 (30.7)	2.10 (5.33)	8.86 (22.5)		860 (59.2)	3440 (237)	0.37 (0.55)
1 (25.4)	1.00 (25.4)	1.51 (38.4)	2.70 (6.86)	10.2 (25.9)		680 (46.8)	2720 (187)	0.50 (0.74)
1 1/2 (38.1)	1.50 (38.1)	2.12 (53.8)	3.90 (9.91)	13.4 (34.0)		520 (35.8)	2080 (143)	0.85 (1.26)
2 (50.8)	2.00 (50.8)	2.67 (67.8)	5.10 (13.0)	15.4 (39.1)		450 (31.0)	1800 (124)	1.10 (1.65)

Pressure-Temperature Ratings

Ratings are based on ASME Code for Pressure Piping, B31.1 Power Piping.

Nominal Hose Size, in.	1/2	3/4	1	1 1/2	2
Temperature °F (°C)	Working Pressure Vacuum to ... psig (bar)				
-325 (-200) to 300 (148)	1110 (76.4)	860 (59.2)	680 (46.8)	520 (35.8)	450 (31.0)
400 (204)	1032 (71.1)	800 (55.1)	632 (43.5)	484 (33.3)	419 (28.8)
500 (260)	955 (65.7)	740 (50.9)	585 (40.2)	447 (30.8)	387 (26.6)
600 (315)	899 (61.9)	697 (47.9)	551 (37.9)	421 (29.0)	365 (25.1)
700 (371)	855 (58.8)	662 (45.6)	524 (36.0)	400 (27.5)	347 (23.8)
750 (398)	833 (57.3)	645 (44.4)	510 (35.1)	390 (26.8)	338 (23.2)
800 (426)	821 (56.5)	636 (43.8)	503 (34.6)	385 (26.5)	333 (22.9)

AH Series Metal Hose

Testing

Every Swagelok AH series hose assembly is inboard helium leak tested to a maximum leak rate of 1×10^{-5} std cm³/s.

For additional testing, see **Testing**, page 108.

Cleaning and Packaging

Swagelok AH series hose components are cleaned in accordance with Swagelok *Standard Cleaning and Packaging (SC-10)* catalog, [MS-06-62](#). Each hose is bagged individually and boxed; longer hoses are coiled, bagged, and boxed.

⚠ Do not subject flexible metal hose to pressure surges, shock, or pulsations, where the peak pressure is greater than 50 % of the working pressure rating.

Ordering Information

Custom Hose Assemblies

Build a hose assembly ordering number by combining the designators in the sequence shown below.

Typical Ordering Number

1 2 3 4 4 5 6 5 6
SS - AH 8 TA 8 PM 8 - 28 - F or **71 CM - F**
in. cm

1 Material

End Connections

SS = 316 stainless steel

2 Hose

AH = AH series metal hose

3 Nominal Hose Size, in.

8 = 1/2	16 = 1
12 = 3/4	24 = 1 1/2
	32 = 2

4 End Connections

See **End Connection Designator** column in tables on next page.

5 Overall Length

Inches or centimeters, in whole numbers. Include **CM** as shown for centimeter lengths.

6 Options

For multiple options, add designators with a dash between each designator.

- A = Armor guard
- F = Fire jacket
- F1 = Thermosleeve
- C = ASTM G93 Level C cleaning on hose wetted surfaces
- G = CGA 4.1 cleaning on hose wetted surfaces
- H = Helium leak test (1×10^{-9} std cm³/s)
- H7 = Helium leak test (1×10^{-7} std cm³/s)
- N3 = Nitrogen pressure test
- W = Hydrostatic test

Mat Tags

- | | |
|------------|-------------|
| MA = Gray | MO = Orange |
| MB = Blue | MP = Purple |
| MC = Brown | MR = Red |
| MG = Green | MW = White |
| MK = Black | MY = Yellow |
| MN = Pink | |

Add 2 to the end of the Mat Tag designator for two tags.

Example: MA2

Other Tags

- T = Lanyard tag
- T2 = Two lanyard tags
- T5 = Clamp tag

Specify text for tags. See **Hose Tag Text** table, page 109.

See page 107 for detailed descriptions of options.

AH Series Metal Hose

End Connections

Swagelok Tube Adapters

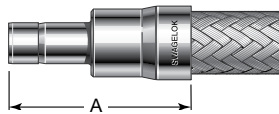

1 in. and Under

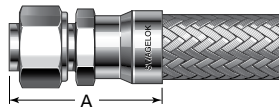

Preswaged Nuts and Ferrules—
Over 1 in. / 25 mm

Tube Adapter Size	Nominal Hose Size Designator	End Connection Designator	A	Minimum Inside Diameter	Maximum Outside Dimension
Dimensions, in. (mm)					
1/2	8	TA8	2.28 (57.9)	0.37 (9.4)	1.08 (27.4)
3/4	12	TA12	2.62 (66.5)	0.58 (14.7)	1.50 (38.1)
1	16	TA16	2.99 (75.9)	0.80 (20.3)	1.79 (45.5)
1 1/2 ^①	24	TA24	4.47 (114)	1.25 (31.8)	2.59 (65.8)
2 ^①	32	TA32	5.70 (145)	1.72 (43.7)	3.45 (87.6)
Dimensions, mm (in.)					
12	8	TM12	67.9 (2.67)	8.9 (0.35)	27.4 (1.08)
18	12	TM18	64.0 (2.52)	14.0 (0.55)	38.1 (1.50)
25	16	TM25	75.9 (2.99)	19.8 (0.78)	45.5 (1.79)
38 ^①	24	TM38	97.3 (3.83)	31.8 (1.25)	69.1 (2.72)

① Furnished with nut, preswaged silver-plated front ferrule and uncoated back ferrule which are required for performance above 450°F (232°C).

Swagelok Tube Fittings

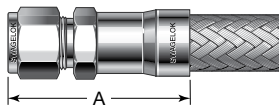

Tube Fitting Size	Nominal Hose Size Designator	End Connection Designator	A	Minimum Inside Diameter	Maximum Outside Dimension
Dimensions, in. (mm)					
1/2	8	SL8	2.56 (65.0)	0.41 (10.4)	1.08 (27.4)
3/4	12	SL12	2.74 (69.6)	0.63 (16.0)	1.50 (38.1)
1	16	SL16	3.20 (81.3)	0.88 (22.4)	1.79 (45.5)
1 1/2 ^①	24	SL24	4.25 (108)	1.35 (34.3)	2.45 (62.2)
2 ^①	32	SL32	5.47 (139)	1.82 (46.2)	3.17 (80.5)
Dimensions, mm (in.)					
12	8	SM12	65.0 (2.56)	9.7 (0.38)	27.4 (1.08)
18	12	SM18	69.6 (2.74)	15.0 (0.59)	38.1 (1.50)
25	16	SM25	81.3 (3.20)	21.8 (0.86)	45.5 (1.79)
38 ^①	24	SM38	111 (4.36)	33.8 (1.33)	63.2 (2.49)

① Furnished with silver-plated front ferrule and uncoated back ferrule which are required for performance above 450°F (232°C).

Rotatable Male VCR Metal Gasket Face Seal Fittings

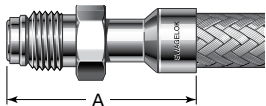

VCR Size in.	Nominal Hose Size Designator	End Connection Designator	Dimensions, in. (mm)		
			A	Minimum Inside Diameter	Maximum Outside Dimension
1/2	8	RM8	2.13 (54.1)	0.40 (10.2)	1.08 (27.4)
3/4	12	RM12	2.75 (69.9)	0.63 (16.0)	1.51 (38.4)
1	16	RM16	2.97 (75.4)	0.88 (22.4)	1.88 (47.8)

Rotatable Female VCR Metal Gasket Face Seal Fittings

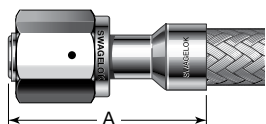

VCR Size in.	Nominal Hose Size Designator	End Connection Designator	Dimensions, in. (mm)		
			A	Minimum Inside Diameter	Maximum Outside Dimension
1/2	8	RF8	2.13 (54.1)	0.40 (10.2)	1.23 (31.2)
3/4	12	RF12	2.75 (69.9)	0.63 (16.0)	1.73 (43.9)
1	16	RF16	2.97 (75.4)	0.88 (22.4)	2.02 (51.3)

AH Series Metal Hose

Female VCO O-Ring Face Seal Fittings

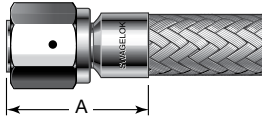

VCO Size in.	Nominal Hose Size Designator	End Connection Designator	Dimensions, in. (mm)		
			A	Minimum Inside Diameter	Maximum Outside Dimension
1/2	8	VF8	1.44 (36.6)	0.41 (10.4)	1.08 (27.4)
3/4	12	VF12	1.69 (42.9)	0.63 (16.0)	1.73 (43.9)
1	16	VF16	1.73 (43.9)	0.88 (22.4)	2.02 (51.3)

SAE 37° (JIC) Female Swivel

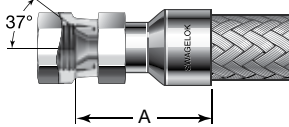

Swivel Size in.	Nominal Hose Size Designator	End Connection Designator	Dimensions, in. (mm)		
			A	Minimum Inside Diameter	Maximum Outside Dimension
1/2	8	AS8	1.51 (38.4)	0.39 (9.9)	1.08 (27.4)
3/4	12	AS12	1.76 (44.7)	0.61 (15.5)	1.50 (38.1)
1	16	AS16	2.08 (52.8)	0.84 (21.3)	1.79 (45.5)

Female Pipe Threads, NPT

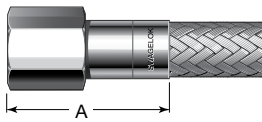

NPT Size in.	Nominal Hose Size Designator	End Connection Designator	Dimensions, in. (mm)		
			A	Minimum Inside Diameter	Maximum Outside Dimension
1/2	8	PF8	2.58 (65.5)	0.58 (14.7)	1.23 (31.2)
3/4	12	PF12	2.53 (64.3)	0.73 (18.5)	1.51 (38.4)
1	16	PF16	2.92 (74.2)	0.95 (24.1)	1.88 (47.8)
1 1/2	24	PF24	3.28 (83.3)	1.50 (38.1)	2.74 (69.6)

Male Pipe Threads, NPT and ISO/BSP Tapered (ISO 7)

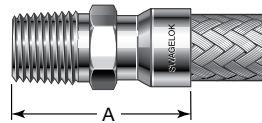

NPT and ISO/BSP Tapered Size in.	Nominal Hose Size Designator	End Connection Designator	Dimensions, in. (mm)		
			A	Minimum Inside Diameter	Maximum Outside Dimension
NPT					
1/2	8	PM8	2.45 (62.2)	0.47 (11.9)	1.08 (27.4)
3/4	12	PM12	2.57 (65.3)	0.63 (16.0)	1.50 (38.1)
1	16	PM16	3.05 (77.5)	0.88 (22.4)	1.79 (45.5)
1 1/2	24	PM24	3.38 (85.9)	1.34 (34.0)	2.45 (62.2)
2	32	PM32	3.88 (98.6)	1.81 (46.0)	2.92 (74.2)
ISO/BSP Tapered					
1/2	8	MT8	2.45 (62.2)	0.47 (11.9)	1.08 (27.4)
3/4	12	MT12	2.57 (65.3)	0.63 (16.0)	1.50 (33.5)
1	16	MT16	3.05 (77.5)	0.88 (22.4)	1.79 (41.4)
1 1/2	24	MT24	3.38 (85.9)	1.34 (34.0)	2.45 (62.6)

Tub Butt Welds

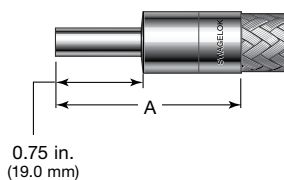

Tube Butt Weld Size in.	Nominal Hose Size Designator	End Connection Designator	Dimensions, in. (mm)		
			A	Minimum Inside Diameter	Maximum Outside Dimension
1/2	8	TB8	2.17 (55.1)	0.40 (10.2)	0.93 (23.6)
3/4	12	TB12	2.27 (57.7)	0.65 (16.5)	1.32 (33.5)
1	16	TB16	2.46 (62.5)	0.87 (22.1)	1.63 (41.4)

FV Series Vacuum-Insulated Metal Hose

Features

- Vacuum layer provides excellent insulation to extreme media temperatures.
- Proprietary design provides two levels of insulating performance in a compact package.
- Vacuum-only insulation can be augmented with multi-layer insulation to also address radiant heat transfer.
- Proprietary manufacturing process does not require the vacuum port, eliminating the primary source of vacuum degradation.
- Fully annealed condition eases hose routing through form-fit-and-stay capability.
- Available in sizes 1/2, 3/4, and 1 in.
- Custom lengths available to meet specific needs.
- 316L stainless steel wetted surfaces are suitable for liquids and gaseous media.
- Wetted braze material meets AMS 4777 (Nickel alloy).
- Colored polyolefin sleeves allow for color-coding process lines.

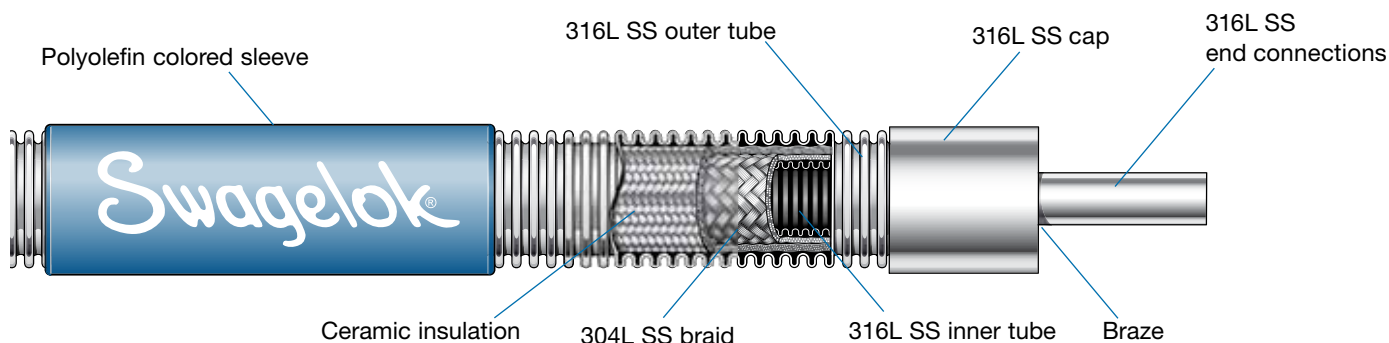

Note: Proprietary radiant barrier not shown.

Technical Data

Nominal Hose Size in. (mm)	Insulation Level	Inside Diameter in. (mm)	Outside Diameter in. (mm)	Minimum Center Line Bend Radius in. (cm)		Temperature Range °F (°C)	Working Pressure 10 ⁻⁹ torr to ... psig (bar)	Minimum Burst Pressure at 70°F (20°C) psig (bar)	Bulk Hose Weight lb/ft (kg/m)
				Static	Dynamic ^①				
1/2 (12.7)	Vacuum	0.47 (11.9)	1.27 (32.3)	5.00 (12.7)	—	-425 to 1000 (-253 to 537)	600 (41.3)	2400 (165)	0.45 (0.67)
	Vacuum & Radiant barrier		1.62 (41.2)	6.15 (15.6)	—				0.66 (0.98)
3/4 (19.0)	Vacuum	0.79 (20.1)	1.62 (41.2)	6.15 (15.6)	—		490 (33.7)	1960 (135)	0.80 (1.19)
	Vacuum & Radiant barrier		2.38 (60.5)	9.41 (23.9)	—				1.13 (1.68)
1 (25.4)	Vacuum	0.98 (25.0)	1.95 (49.5)	7.62 (19.4)	—		400 (27.5)	1600 (110)	1.02 (1.52)
	Vacuum & Radiant barrier		2.38 (60.5)	9.41 (23.9)	—				1.25 (1.86)

① Annealed product is not rated for highly dynamic applications.

Pressure-Temperature Ratings

Ratings are based on ASME Code for Pressure Piping, B31.3 Process Piping.

Nominal Hose Size, in.	1/2	3/4	1
Temperature °F (°C)	Working Pressure Vacuum to ... psig (bar)		
-425 (-253) to 300 (148)	600 (41.3)	490 (33.7)	400 (27.5)
400 (204)	567 (39.0)	463 (31.9)	378 (26.0)
500 (260)	531 (36.5)	434 (29.9)	354 (24.3)
600 (315)	502 (34.5)	410 (28.2)	335 (23.0)
700 (371)	484 (33.3)	395 (27.2)	323 (22.2)
800 (426)	466 (32.1)	381 (26.2)	311 (21.4)
900 (482)	427 (29.4)	348 (23.9)	284 (19.5)
1000 (537)	280 (19.2)	228 (15.7)	186 (12.8)

FV Series Vacuum-Insulated Metal Hose

Testing

Every Swagelok FV series hose assembly is thermally tested to confirm insulation performance and leak tightness of vacuum.

Cleaning and Packaging

Swagelok FV series hose assemblies are cleaned in accordance with Swagelok *Standard Cleaning and Packaging (SC-10)* catalog, [MS-06-62](#). Each hose is bagged or sleeved individually and boxed.

⚠ Do not subject flexible metal hose to pressure surges, shock, or pulsations, where the peak pressure is greater than 50 % of the working pressure rating.

Ordering Information

Custom Hose Assemblies

Build a hose assembly ordering number by combining the designators in the sequence shown below.

Typical Ordering Number

1 2 3 4 4 5 6 7 8 5 6 7 8
 SS - FV 8 TN8 TN8 - 36 - T - QB1 or 90CM - T - QB1
in. cm

1 Material

End Connections

SS = 316L stainless steel

2 Hose

FV = FV series metal hose

3 Nominal Hose Size, in.

- 8 = 1/2
- 12 = 3/4
- 16 = 1

4 End Connections

See *End Connection Designator column in table below.*

5 Overall Length

Inches or centimeters, in whole numbers. Include CM as shown for centimeter lengths.

*Minimum length is 18 in. (46 cm).
Maximum length is 720 in. (1820 cm).*

Hoses 50 in. and less have a tolerance of ±1.5 in. Hoses longer than 50 in. have a tolerance of ±3%.

Ordered length is unpressurized. Hose length will extend up to approximately 5% when pressurized.

6 Options

- T = Lanyard Tag
- T2 = Two lanyard tags

7 Sleeve Color

- QB = Blue
- QR = Red
- QK = Black
- QW = White

8 Insulation Level

- 1 = Vacuum
- 2 = Vacuum & Radiant barrier

End Connections

Tube Stubs, Annealed

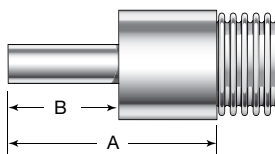

Hose Size in.	Wall Thickness, in.	End Connection Designator	Dimensions, in. (mm)			
			Maximum A	Minimum to Maximum Tube Stub Length B	Minimum Inside Diameter	Maximum Outside Dimension
1/2	0.035	TN8	3.26 (82.8)	1.25 (31.8) to 2.25 (57.2)	0.41 (10.4)	1.71 (43.4)
3/4	0.049	TN12	3.26 (82.8)	1.25 (31.8) to 2.25 (57.2)	0.63 (16.0)	2.51 (63.8)
1	0.065	TN16	3.51 (89.2)	1.50 (38.1) to 2.50 (63.5)	0.85 (21.6)	2.51 (63.8)

FV Series Vacuum-Insulated Metal Hose

Estimated Hose Surface versus Media Temperature on 3/4 in. FV Series Hose

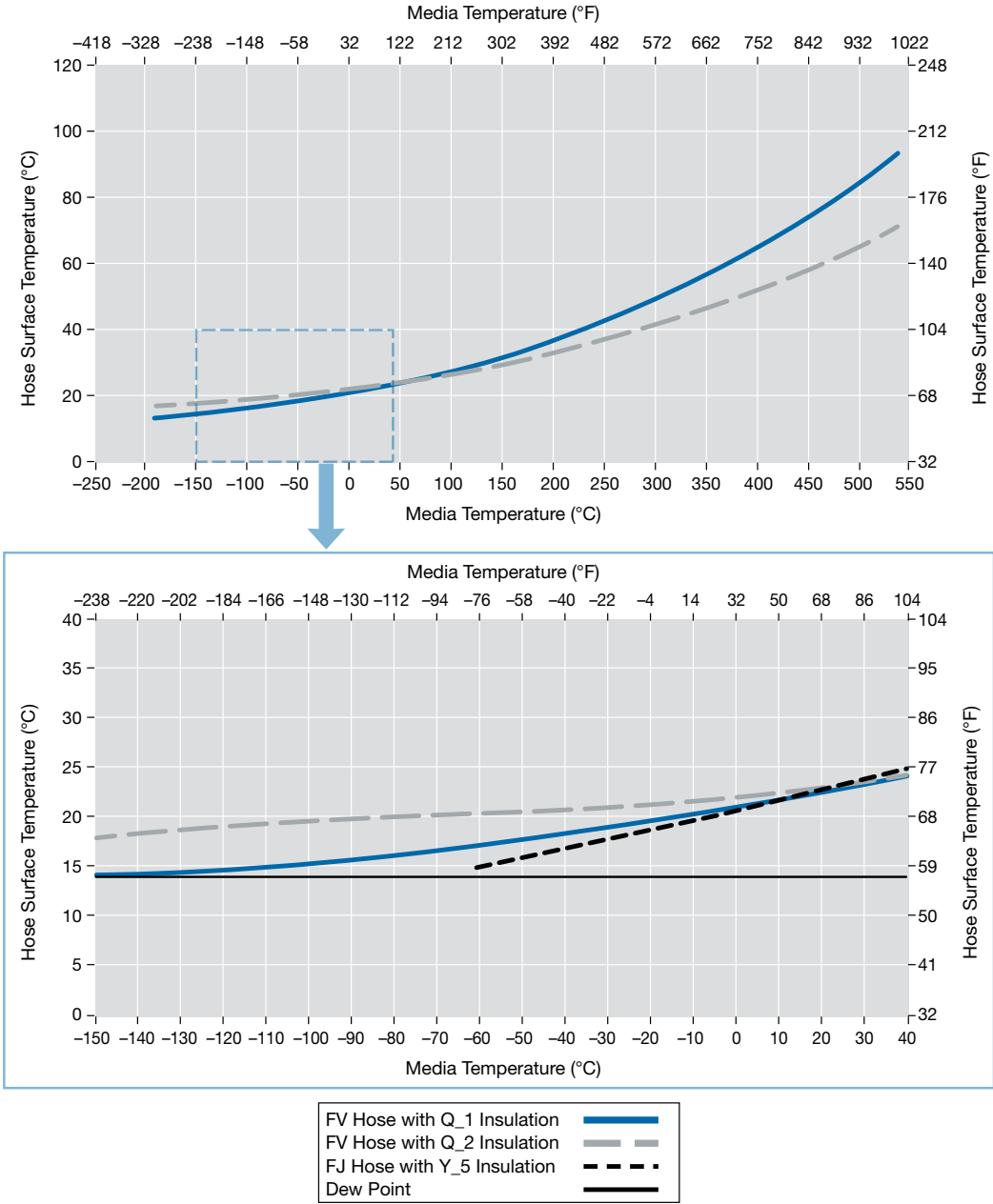

Test conditions for example plots

- Ambient air temperature: 23°C (73°F)
- Relative humidity: 55%
- Air flow: isolated in a chamber with minimal air flow
- Media pressure: 8 psig (0.55 bar)
- Media flow rate: 24 l/min
- Media type: liquid
- Plot information applicable to hose live length.

Insulation Option Definition

Q_1 insulation is a vacuum design resistant to internal convective and conductive heat transfer.

Q_2 insulation adds a radiant barrier to the vacuum design, adding resistance to radiant heat transfer and additional conductive resistance.

See page 112 for considerations on insulated hoses.

For more information, contact your authorized Swagelok sales and service center.

FN Series Metal Tubing

Features

- 316L stainless steel annular convoluted core.
- Size range of 1/4 through 1/2 in. and working pressures up to 135 psig (9.3 bar).
- Form-fit-and-stay capability of tubing assemblies can compensate for misalignment and system reroutes between static connections in vacuum or low-pressure static applications.
- Commonly used in high-temperature vacuum or low-pressure applications where permeation is undesirable.
- Custom assemblies available.
- Options include tubing tags, additional cleaning, and additional helium leak testing. See pages 107 and 109 for details.
- For electrical properties, see page 5 for details.

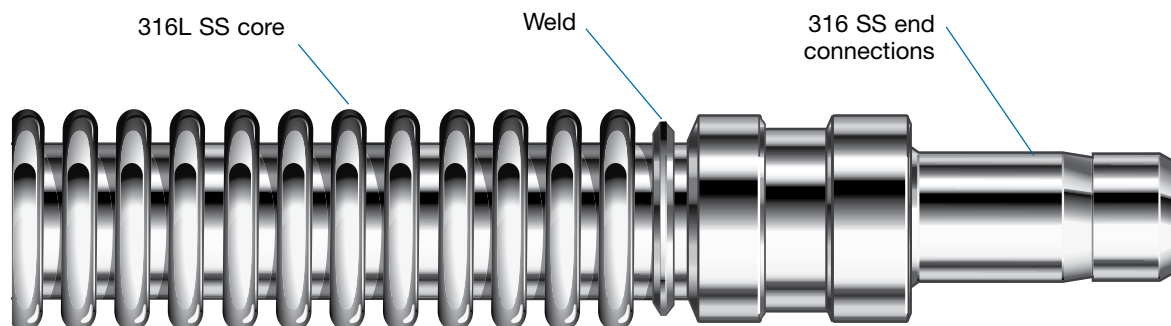

Technical Data

Nominal Tubing Size in. (mm)	Inside Diameter in. (mm)	Outside Diameter in. (mm)	Minimum Center Line Bend Radius in. (cm)		Temperature Range °F (°C)	Working Pressure at -325 to 300°F (-200 to 148°C) 10-9 torr to ... psig (bar)	Nominal Tubing Wall Thickness in. (mm)	Tubing Weight lb/ft (kg/m)
			Static	Dynamic ^①				
1/4 (6.4)	0.27 (6.9)	0.41 (10.4)	1.00 (2.54)	—	-325 to 1000 (-200 to 537)	135 (9.3)	0.006 (0.15)	0.04 (0.06)
3/8 (9.7)	0.38 (9.7)	0.54 (13.7)	1.20 (3.05)	—		65 (4.4)	0.006 (0.15)	0.06 (0.09)
1/2 (12.7)	0.53 (13.5)	0.75 (19.1)	1.50 (3.81)	—		60 (4.1)	0.008 (0.20)	0.11 (0.16)
3/4 (19.0)	0.78 (19.8)	1.21 (30.7)	2.1 (5.3)	—		23 (1.5)	0.010 (0.25)	0.19 (0.28)
1 (25.4)	1.04 (26.4)	1.44 (36.6)	2.7 (6.9)	—		18 (1.2)	0.010 (0.25)	0.26 (0.39)
1 1/2 (38.1)	1.58 (40.1)	2.04 (51.8)	3.9 (9.9)	—		10 (0.68)	0.012 (0.30)	0.47 (0.70)
2 (50.8)	2.05 (52.1)	2.59 (65.8)	5.1 (13)	—		6 (0.41)	0.012 (0.30)	0.59 (0.88)

^① Annealed product is not rated for highly dynamic applications.

Pressure-Temperature Ratings

Ratings are based on ASME Code for Pressure Piping B31.3, Process Piping.

Nominal Tube Size, in.	1/4	3/8	1/2	3/4	1	1 1/2	2
Temperature °F (°C)	Working Pressure Vacuum to ... psig (bar)						
-325 (-200) to 300 (148)	135 (9.3)	65 (4.4)	60 (4.1)	23 (1.5)	18 (1.2)	10 (0.68)	6 (0.41)
400 (204)	127 (8.7)	61 (4.2)	56 (3.8)	21 (1.4)	16 (1.1)	9 (0.62)	5 (0.34)
500 (260)	120 (8.2)	58 (3.9)	53 (3.6)	20 (1.3)	16 (1.1)	8 (0.55)	5 (0.34)
600 (315)	113 (7.8)	55 (3.7)	50 (3.4)	19 (1.3)	15 (1.0)	8 (0.55)	5 (0.34)
700 (371)	109 (7.5)	53 (3.6)	49 (3.3)	18 (1.2)	14 (0.96)	8 (0.55)	4 (0.27)
800 (426)	104 (7.1)	50 (3.4)	46 (3.1)	17 (1.1)	13 (0.89)	7 (0.48)	4 (0.27)
900 (482)	100 (6.8)	48 (3.3)	44 (3.0)	17 (1.1)	13 (0.89)	7 (0.48)	4 (0.27)
1000 (537)	96 (6.6)	46 (3.1)	43 (2.9)	16 (1.1)	12 (0.82)	7 (0.48)	4 (0.27)

Testing

Every Swagelok FN series tube assembly is inboard helium leak tested to a maximum leak rate of 1×10^{-7} std cm³/s.

For additional testing, see **Testing**, page 108.

Cleaning and Packaging

Swagelok FN series tube components are cleaned in accordance with Swagelok *Standard Cleaning and Packaging (SC-10)* catalog, [MS-06-62](#).

Each tube is bagged or sleeved individually and boxed; longer tubes are coiled, bagged, and boxed.

⚠ Do not subject flexible metal tube to pressure surges, shock, or pulsations, where the peak pressure is greater than 50 % of the working pressure rating.

FN Series Metal Tubing

Ordering Information

Custom Tube Assemblies

Build a tube assembly ordering number by combining the designators in the sequence shown below.

Typical Ordering Number

1 2 3 4 4 5 6 5 6
SS - FN 4 TA 4 RF 4 - 36 - H or **90 CM - H**
|-----| in. |-----| or |-----| cm |-----|

1 Material

End Connections

SS = 316 stainless steel

2 Tube

FN = FN series annealed metal tube

3 Nominal Tube Size, in.

4 = 1/4

6 = 3/8

8 = 1/2

4 End Connections

See **End Connection Designator** column in tables on page 44.

5 Overall Length

Inches to one decimal, or centimeters in whole numbers. Include **CM** as shown for centimeter lengths.

Maximum length is 96 in (244 cm).

For longer lengths, please contact your authorized Swagelok sales and service center.

6 Options

For multiple options, add designators with a dash between each designator.

C = ASTM G93 Level C cleaning on tube wetted surfaces

G = CGA 4.1 cleaning on tube wetted surfaces

H = Helium leak test
(1×10^{-9} std cm³/s)

T = Lanyard tag

T2 = Two lanyard tags

FZ Series Metal Tubing

Features

- 316L stainless steel annular convoluted core.
- Size range of 1/4 through 1/2 in. and working pressures up to 250 psig (17.2 bar).
- Non-annealed all-metal tubing can be used in dynamic applications.
- Commonly used in high-temperature vacuum or low-pressure applications where permeation is undesirable.
- Custom assemblies available.
- Options include tubing tags, additional cleaning, and additional helium leak testing. See pages 107 and 109 for details.
- For electrical properties, see page 5 for details.

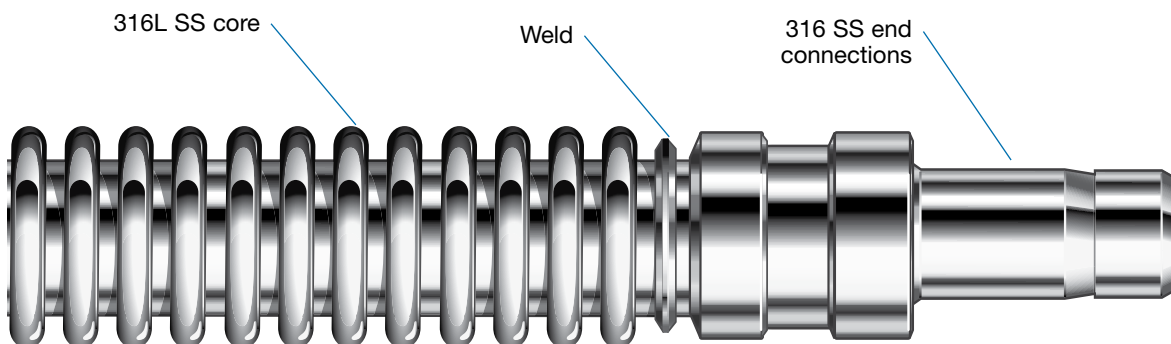

Technical Data

Nominal Tubing Size in. (mm)	Inside Diameter in. (mm)	Outside Diameter in. (mm)	Minimum Center Line Bend Radius in. (cm)		Temperature Range °F (°C)	Working Pressure at -325 to 300°F (-200 to 148°C) 10-9 torr to ... psig (bar)	Nominal Tubing Wall Thickness in. (mm)	Tubing Weight lb/ft (kg/m)
			Static	Dynamic				
1/4 (6.4)	0.27 (6.9)	0.41 (10.4)	1.00 (2.54)	4.50 (11.4)	-325 to 1000 (-200 to 537)	250 (17.2)	0.006 (0.15)	0.04 (0.06)
3/8 (9.7)	0.38 (9.7)	0.54 (13.7)	1.20 (3.05)	5.00 (12.7)		105 (7.2)	0.006 (0.15)	0.06 (0.09)
1/2 (12.7)	0.53 (13.5)	0.75 (19.1)	1.50 (3.81)	5.50 (13.9)		95 (6.5)	0.008 (0.20)	0.11 (0.16)

Pressure-Temperature Ratings

Ratings are based on ASME Code for Pressure Piping B31.3, Process Piping.

Nominal Tube Size, in.	1/4	3/8	1/2
Temperature °F (°C)	Working Pressure Vacuum to ... psig (bar)		
-325 (-200) to 300 (148)	250 (17.2)	105 (7.2)	95 (6.5)
400 (204)	235 (16.1)	99 (6.8)	89 (6.1)
500 (260)	223 (15.3)	93 (6.4)	85 (5.8)
600 (315)	210 (14.4)	88 (6.0)	80 (5.4)
700 (371)	203 (13.9)	85 (5.8)	77 (5.3)
800 (426)	193 (13.2)	81 (5.5)	73 (5.0)
900 (482)	185 (12.7)	78 (5.3)	70 (4.8)
1000 (537)	178 (12.2)	75 (5.1)	67 (4.6)

Testing

Every Swagelok FZ series tube assembly is inboard helium leak tested to a maximum leak rate of 1×10^{-7} std cm³/s.

For additional testing, see **Testing**, page 108.

Cleaning and Packaging

Swagelok FZ series tube components are cleaned in accordance with Swagelok *Standard Cleaning and Packaging (SC-10)* catalog, [MS-06-62](#).

Each tube is bagged or sleeved individually and boxed; longer tubes are coiled, bagged, and boxed.

⚠ Do not subject flexible metal tube to pressure surges, shock, or pulsations, where the peak pressure is greater than 50 % of the working pressure rating.

FZ Series Metal Tubing

Ordering Information

Custom Tube Assemblies

Build a tube assembly ordering number by combining the designators in the sequence shown below.

Typical Ordering Number

1 2 3 4 4 5 6 5 6
SS - FZ 4 TA 4 RF 4 - 36 - H or **90 CM - H**
in. cm

1 Material

End Connections

SS = 316 stainless steel

2 Tube

FZ = FZ series metal tube

3 Nominal Tube Size, in.

4 = 1/4

6 = 3/8

8 = 1/2

4 End Connections

See **End Connection Designator** column in tables on page 44.

5 Overall Length

Inches to one decimal, or centimeters in whole numbers. Include **CM** as shown for centimeter lengths.

Maximum length is 480 in. (1219 cm).

6 Options

For multiple options, add designators with a dash between each designator.

C = ASTM G93 Level C cleaning on tube wetted surfaces

G = CGA 4.1 cleaning on tube wetted surfaces

H = Helium leak test
(1×10^{-9} std cm³/s)

T = Lanyard tag

T2 = Two lanyard tags

FN and FZ Series Metal Tubing

End Connections

Swagelok Tube Adapters

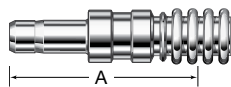

1/2 in. and Under.



3/4 and 1 in.

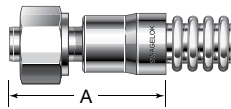

Over 1 in.

Tube Adapter Size	Nominal Tube Size	End Connection Designator	Dimensions		
			Rigid Length A	Minimum Inside Diameter	Maximum Outside Dimension
Dimensions, in. (mm)					
1/4	4	TA4	1.58 (40.1)	0.17 (4.3)	0.36 (9.1)
3/8	6	TA6	1.65 (41.9)	0.28 (7.1)	0.50 (12.7)
1/2	8	TA8	2.02 (51.3)	0.40 (10.2)	0.61 (15.5)
3/4	12	TA12	2.50 (63.5)	0.58 (14.7)	1.33 (33.8)
1	16	TA16	2.99 (75.9)	0.80 (20.3)	1.74 (44.2)
1 1/2	24	TA24	4.47 (114)	1.25 (31.8)	2.59 (65.8)
2	32	TA32	5.45 (138)	1.72 (43.7)	3.45 (87.6)

Tube Butt Welds

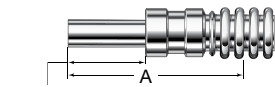

0.75 in. (19.0 mm)

1/2 in. and Under.

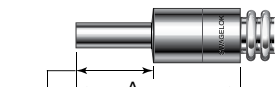

0.75 in. (19.0 mm)

Over 1/2 in.

Tube Butt Weld Size	Nominal Tube Size	End Connection Designator	Dimensions		
			Rigid Length A	Minimum Inside Diameter	Maximum Outside Dimension
Dimensions, in. (mm)					
1/4	4	TB4	1.70 (43.2)	0.17 (4.3)	0.36 (9.1)
3/8	6	TB6	1.71 (43.4)	0.28 (7.1)	0.50 (12.7)
1/2	8	TB8	1.82 (46.2)	0.40 (10.2)	0.61 (15.5)
3/4	12	TB12	2.14 (54.4)	0.65 (16.5)	1.33 (33.8)
1	16	TB16	2.46 (62.5)	0.86 (21.8)	1.57 (39.9)

Rotatable Male VCR Metal Gasket Face Seal Fittings

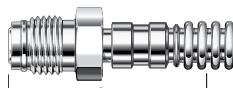

1/2 in. and Under.

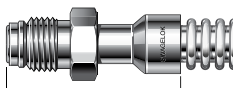

Over 1/2 in.

VCR Size	Nominal Tube Size	End Connection Designator	Dimensions		
			Rigid Length A	Minimum Inside Diameter	Maximum Outside Dimension
Dimensions, in. (mm)					
1/4	4	RM4	1.69 (42.9)	0.17 (4.3)	0.87 (22.1)
1/2	6	RM8	1.89 (48.0)	0.28 (7.1)	1.22 (31.0)
1/2	8	RM8	2.00 (50.8)	0.40 (10.2)	1.22 (31.0)
3/4	12	RM12	2.63 (66.8)	0.62 (15.7)	1.52 (38.6)
1	16	RM16	2.97 (75.4)	0.87 (22.1)	1.88 (47.8)

FN and FZ Series Metal Tubing

Rotatable Female VCR Metal Gasket Face Seal Fittings

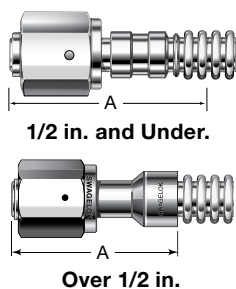

VCR Size	Nominal Tube Size	End Connection Designator	Dimensions		
			Rigid Length A	Minimum Inside Diameter	Maximum Outside Dimension
Dimensions, in. (mm)					
1/4	4	RF4	1.69 (42.9)	0.17 (4.3)	0.87 (22.1)
1/2	6	RF8	1.89 (48.0)	0.28 (7.1)	1.22 (31.0)
1/2	8	RF8	2.00 (50.8)	0.40 (10.2)	1.22 (31.0)
3/4	12	RF12	2.63 (66.8)	0.62 (15.7)	1.74 (44.2)
1	16	RF16	2.97 (75.4)	0.87 (22.1)	2.03 (51.6)

Female VCO O-Ring Face Seal Fittings

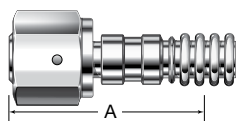

VCO Size	Nominal Tube Size	End Connection Designator	Dimensions		
			Rigid Length A	Minimum Inside Diameter	Maximum Outside Dimension
Dimensions, in. (mm)					
1/4	4	VF4	1.30 (33.0)	0.17 (4.3)	0.79 (20.1)
1/2	6	VF8	1.32 (33.5)	0.28 (7.1)	1.15 (29.2)
1/2	8	VF8	1.43 (36.3)	0.40 (10.2)	1.15 (29.2)

FP Series Hybrid Hose

Features

- PTFE smooth bore core hose.
- 316L stainless steel convoluted cover.
- Sizes of 1/4 and 1/2 in. and working pressures from vacuum to 165 psig (11.3 bar).
- End connections welded in accordance with ASME Boiler and Pressure Vessel Code Section IX.
- Commonly used as a low pressure transfer hose where a smooth bore for ultra-high purity is critical and permeation to the atmosphere is undesirable.

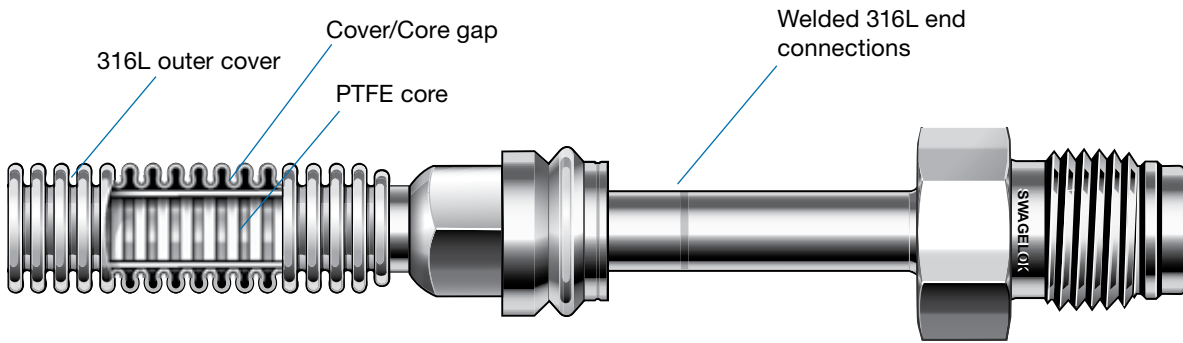

Technical Data

Nominal Hose Size in. (mm)	Inside Diameter in. (mm)	Outside Diameter in. (mm)	Minimum Center Line Bend Radius in. (cm)		Temperature Range °F (°C)	Working Pressure at 0 to 120°F (-17 to 48°C) Vacuum to ... psig (bar)	Minimum Permanent Deformation Pressure at 70°F (20°C) psig (bar)
			Static	Dynamic			
1/4 (6.4)	0.18 (4.6)	0.38 (9.7)	2.13 (5.4)	4.33 (10.9)	0 to 120 (-17 to 48)	165 (11.3)	464 (32.0)
1/2 (12.7)	0.37 (9.4)	0.73 (18.5)	4.33 (10.9)	6.50 (16.5)		165 (11.3)	464 (32.0)

Pressure-temperature ratings may be limited by the end connections. Exceeding the minimum permanent deformation pressure could result in core tube distortion.

Testing

Every Swagelok FP series hose assembly is inboard helium leak tested to a maximum leak rate of 1×10^{-9} std cm³/s.

For additional testing, see **Testing**, page 108

Cleaning and Packaging

Each hose is bagged individually and boxed.

⚠ Permeation of gases will occur between the PTFE core and the convoluted metal layer. When system pressure is reduced, reverse permeation back into the flow path may occur. Contact your Swagelok representative for additional information.

FP Series Hybrid Hose

Ordering Information

Custom Hose Assemblies

Build a hose assembly ordering number by combining the designators in the sequence shown below.

Typical Ordering Number

1 2 3 4 4 - 5 6 or 5 6
 6 L - FP 4 TA4 RF4 - 28 - APC or 71 CM - APC
in. cm

1 Material

End Connections

6L = 316L stainless steel

2 Hose

FP = FP series hose

3 Nominal Hose Size, in.

4 = 1/4 8 = 1/2

4 End Connections

See **End Connection Designator** column in tables on next page.

5 Overall Length

Inches in tenths or centimeters, in whole numbers. Include **CM** as shown for centimeter lengths. Available lengths between 6-47 inches.

6 Options

For multiple options, add designators with a dash between each designator.

APC = Airborne Particle Count

RGA = Residual Gas Analysis

UVA = Ultra Violet Inspection

TOC = Total Organic Carbon Measurement

FP Series Hybrid Hose

End Connections

Butt Weld Connection

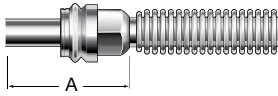

Butt Weld Size	Nominal Hose Size Designator	End Connection Designator	Dimensions		
			A	Minimum Inside Diameter	Maximum Outside Dimension
Dimensions, in. (mm)					
1/4	4	TB4	0.84 (21.3)	0.18 (4.6)	0.25 (6.4)
1/2	8	TB8	1.06 (26.9)	0.40 (10.2)	0.50 (12.7)

Swagelok Tube Adapters

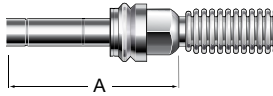

Tube Adapter Size	Nominal Hose Size Designator	End Connection Designator	Dimensions		
			A	Minimum Inside Diameter	Maximum Outside Dimension
Dimensions, in. (mm)					
1/4	4	TA4	2.24 (56.9)	0.18 (4.6)	0.25 (6.4)
1/2	8	TA8	2.79 (70.9)	0.37 (9.4)	0.50 (12.7)

Rotatable Male VCR® Metal Gasket Face Seal Fittings

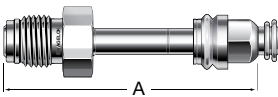

VCR Size	Nominal Hose Size Designator	End Connection Designator	Dimensions		
			A	Minimum Inside Diameter	Maximum Outside Dimension
Dimensions, in. (mm)					
1/4	4	RM4	2.04 (51.8)	0.18 (4.6)	0.78 (19.8)
1/2	8	RM8	2.35 (59.7)	0.40 (10.2)	1.08 (27.4)

Rotatable Female VCR Metal Gasket Face Seal Fittings

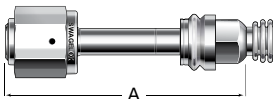

VCR Size	Nominal Hose Size Designator	End Connection Designator	Dimensions		
			A	Minimum Inside Diameter	Maximum Outside Dimension
Dimensions, in. (mm)					
1/4	4	RF4	2.04 (51.8)	0.16 (4.1)	0.87 (22.1)
1/2	8	RF8	2.35 (59.7)	0.34 (8.6)	1.23 (31.2)

Female VCO O-Ring Face Seal Fittings

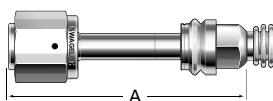

VCO Size	Nominal Hose Size Designator	End Connection Designator	Dimensions		
			A	Minimum Inside Diameter	Maximum Outside Dimension
Dimensions, in. (mm)					
1/4	4	VF4	1.44 (36.6)	0.19 (4.8)	0.79 (20.1)
1/2	8	VF8	1.66 (41.9)	0.41 (10.4)	1.08 (27.4)

T Series PTFE Hose

Features

- PTFE hose with permeation-resistant features.
- Smooth-bore PTFE core.
- Size range of 1/4 through 1 in. and working pressures up to 3000 psig (206 bar).
- Single braid layer of 304 stainless steel (316L SS and alloy 400 available) ensures hose pressure containment and protects the core from abrasion.
- PTFE material complies with FDA regulation 21CFR Part 177.1550.
- Optional carbon black-filled PTFE core is available for applications that require static dissipation.
- Select static dissipative hose assemblies are approved to ECE R110; see page 110 for more information.
- Commonly used where chemical compatibility and permeation resistance is desired.
- Standard and custom assemblies available.
- Options include hose covers, hose tags, and additional cleaning. See page 107 for details.
- For electrical properties, see page 5 for details.

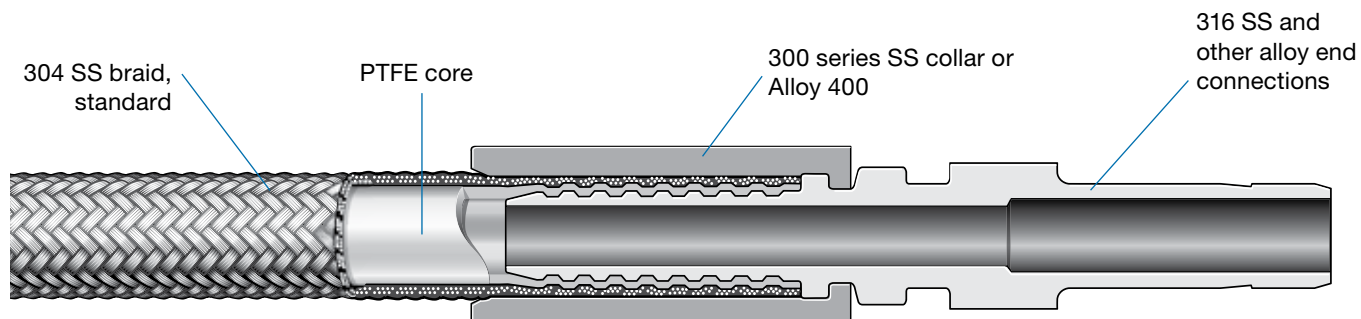

Technical Data

Nominal Hose Size in. (mm)	Inside Diameter in. (mm)	Outside Diameter in. (mm)	Minimum Inside Bend Radius in. (cm)		Temperature Range °F (°C)	Vacuum (28.5 in.Hg [96.5 kPa]) Rated to ... °F (°C)	Working Pressure at 70°F (20°C) psig (bar)	Minimum Burst Pressure at 70°F (20°C) psig (bar)	Bulk Hose Weight lb/ft (kg/m)
			Static	Dynamic					
304 SS Braid (TH and TC)									
1/4 (6.4)	0.19 (4.8)	0.31 (7.9)	1.50 (3.81)	2.00 (5.08)	-65 to 450 (-53 to 230)	450 (230)	3000 (206)	12 000 (826)	0.08 (0.12)
3/8 (9.5)	0.31 (7.9)	0.44 (11.1)	3.50 (8.89)	5.00 (12.7)		450 (230)	2500 (172)	10 000 (689)	0.12 (0.17)
1/2 (12.7)	0.41 (10.3)	0.56 (14.3)	4.50 (11.4)	6.00 (15.2)		450 (230)	2000 (137)	8 000 (551)	0.15 (0.22)
3/4 (19.0)	0.63 (15.9)	0.81 (20.6)	6.00 (15.2)	7.50 (19.0)		450 (230)	1500 (103)	6 000 (413)	0.28 (0.41)
1 (25.4)	0.88 (22.2)	1.03 (26.2)	9.00 (22.9)	11.3 (28.7)		400 (204)	1000 (68.9)	4 000 (275)	0.39 (0.58)
Alloy 400 Braid (TL4)									
1/4 (6.4)	0.19 (4.8)	0.31 (7.9)	1.50 (3.81)	2.00 (5.08)	-65 to 450 (-53 to 230)	450 (230)	1500 (103)	6 000 (413)	0.08 (0.12)

Pressure-Temperature Ratings

Ratings are based on burst testing.

Braid Material	304 SS (TH and TC)					Alloy 400 (TL4)	
	Nominal Hose Size in.	1/4	3/8	1/2	3/4		1
Temperature °F (°C)		Working Pressure, psig (bar)					
-65 (-53)	2250 (155)	2250 (155)	2000 (137)	1500 (103)	1000 (68.9)	1500 (103)	
0 (-17) to 100 (37)	3000 (206)	2500 (172)	2000 (137)	1500 (103)	1000 (68.9)	1500 (103)	
200 (93)	2250 (155)	1875 (129)	1500 (103)	1125 (77.6)	750 (51.7)	1500 (103)	
300 (148) to 450 (230)	2250 (155)	1875 (129)	1500 (103)	1125 (77.6)	750 (51.7)	1215 (83.7)	

Testing

Every Swagelok T series hose assembly is pressure tested with water for 30 to 60 seconds at 1.5 times the working pressure to a requirement of no visible leakage at ambient temperature.

Cleaning and Packaging

Swagelok T series hose components are cleaned in accordance with Swagelok *Standard Cleaning and Packaging (SC-10)* catalog, [MS-06-62](#). Each hose is bagged individually and boxed; longer hoses are coiled, bagged, and boxed.

T Series PTFE Hose

Ordering Information and Dimensions

Standard Length Hose Assemblies

Select an ordering number.

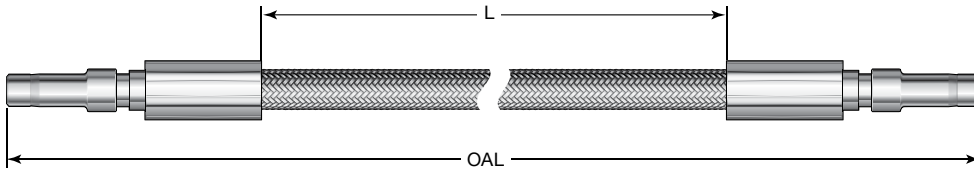

Swagelok Tube Adapter End Connections

Nominal Hose Size	Tube Adapter Size	Overall Length OAL	Ordering Number	Dimensions		
				Live Length L	End Connection Inside Diameter	Maximum Outside Dimension
Dimensions, in.		in. (cm)		in. (cm)	in. (mm)	
1/4	1/4	8.00 (20.3)	SS-4BHT-6	3.92 (10.0)	0.13 (3.3)	0.49 (12.4)
		14.0 (35.6)	SS-4BHT-12	9.92 (25.2)		
		20.0 (50.8)	SS-4BHT-18	15.9 (40.4)		
		26.0 (66.0)	SS-4BHT-24	21.9 (55.6)		
		38.0 (96.5)	SS-4BHT-36	33.9 (86.1)		
		50.0 (127)	SS-4BHT-48	45.9 (117)		
		62.0 (157)	SS-4BHT-60	57.9 (147)		
		74.0 (188)	SS-4BHT-72	69.9 (178)		
		122 (310)	SS-4BHT-120	118 (300)		
3/8	3/8	14.0 (35.6)	SS-6BHT-12	9.64 (24.5)	0.23 (5.8)	0.59 (15.0)
		20.0 (50.8)	SS-6BHT-18	15.6 (39.6)		
		26.0 (66.0)	SS-6BHT-24	21.6 (54.9)		
		38.0 (96.5)	SS-6BHT-36	33.6 (85.3)		
		50.0 (127)	SS-6BHT-48	45.6 (116)		
		62.0 (157)	SS-6BHT-60	57.6 (146)		
		74.0 (188)	SS-6BHT-72	69.6 (177)		
1/2	1/2	14.5 (36.8)	SS-8BHT-12	9.04 (23.0)	0.34 (8.6)	0.78 (19.8)
		20.5 (52.1)	SS-8BHT-18	15.0 (38.1)		
		26.5 (67.3)	SS-8BHT-24	21.0 (53.3)		
		38.5 (97.8)	SS-8BHT-36	33.0 (83.8)		
		50.5 (128)	SS-8BHT-48	45.0 (114)		
		62.5 (159)	SS-8BHT-60	57.0 (145)		
		74.5 (189)	SS-8BHT-72	69.0 (175)		
		122.5 (311)	SS-8BHT-120	117 (297)		
3/4	3/4	26.5 (67.3)	SS-12BHT-24	20.7 (52.6)	0.54 (13.7)	1.04 (26.4)
		38.5 (97.8)	SS-12BHT-36	32.7 (83.1)		
		50.5 (128)	SS-12BHT-48	44.7 (114)		
Dimensions, mm		cm (in.)		cm (in.)	mm (in.)	
1/4 in.	6	35.6 (14.0)	SS-4MBHT-12	25.2 (9.92)	3.3 (0.13)	12.4 (0.49)
		66.0 (26.0)	SS-4MBHT-24	55.7 (21.9)		
		96.5 (38.0)	SS-4MBHT-36	86.2 (33.9)		
1/2 in.	12	67.3 (26.5)	SS-8MBHT-24	53.4 (21.0)	8.6 (0.34)	19.8 (0.78)
		97.8 (38.5)	SS-8MBHT-36	83.9 (33.0)		

T Series PTFE Hose

Ordering Information

Custom Hose Assemblies

Build a hose assembly ordering number by combining the designators in the sequence shown below.

Typical Ordering Number

1 2 3 4 4 5 6 5 6
SS - TH 4 TA 4 SL 2 - 28 - Z or **71 CM - Z**
└─── in. ───┘ or └─── cm ───┘

1 Material

End Connections

SS = 316 stainless steel
M = Alloy 400
HC = Alloy C-276
TI = Titanium, grade 4

Only wetted components will be made of the requested material, with the exception of Alloy 400 on TL hoses. Contact your authorized Swagelok sales and service representative with component material questions.

2 Hose

TH = T series PTFE hose with 304 SS braid
TC = T series carbon black-filled PTFE hose with 304 SS braid
TL = T series PTFE hose with alloy 400 braid (1/4 in. hose size only)

3 Nominal Hose Size, in.

4 = 1/4
6 = 3/8
8 = 1/2
12 = 3/4
16 = 1

4 End Connections

See **End Connection Designator** column in tables on next page.

5 Overall Length

*Inches or centimeters, in whole numbers. Include **CM** as shown for centimeter lengths.*

6 Options

For multiple options, add designators with a dash between each designator.

C = ASTM G93 Level C cleaning on hose wetted surfaces
F = Fire jacket
F1 = Thermosleeve
N3 = Nitrogen pressure test
S = 302 SS spring guard, hose-length
W = Hydrostatic test
Z = 316 SS braid material (1/4 and 3/8 in. TH series hoses only)
093 = ECE R110 approval, only on select end connections for TC hose. (See page 110 for additional information.)

Mat Tags

MA = Gray **MO** = Orange
MB = Blue **MP** = Purple
MC = Brown **MR** = Red
MG = Green **MW** = White
MK = Black **MY** = Yellow
MN = Pink

Add 2 to the end of the Mat Tag designator for two tags.

Example: MA2

Other Tags

T = Lanyard tag
T2 = Two lanyard tags
T5 = Clamp tag

*Specify text for tags. see **Hose Tag Text** table, page 109.*

See page 107 for detailed descriptions of options.

T Series PTFE Hose

End Connections

Swagelok Tube Adapters

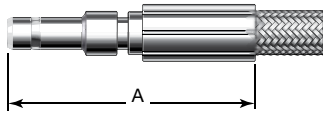

Tube Adapter Size	Nominal Hose Size Designator	End Connection Designator	Dimensions		
			A	End Connection Inside Diameter	Maximum Outside Dimension
Dimensions, in. (mm)					
1/4	4	TA4 ^①	2.04 (51.8)	0.13 (3.3)	0.49 (12.4)
3/8	6	TA6 ^①	2.18 (55.4)	0.23 (5.8)	0.78 (19.8)
	8	TA6 ^①	2.47 (62.7)	0.26 (6.6)	
1/2	8	TA8 ^①	2.73 (69.3)	0.34 (8.6)	
3/4	12	TA12	2.90 (73.7)	0.54 (13.7)	1.04 (26.4)
	16	TA12	3.37 (85.6)	0.58 (14.7)	1.35 (34.3)
1	12	TA16	3.25 (82.6)	0.54 (13.7)	1.24 (31.5)
	16	TA16	3.65 (92.7)	0.78 (19.8)	1.35 (34.3)
Dimensions, mm (in.)					
6	4	TM6 ^①	51.8 (2.04)	3.3 (0.13)	12.4 (0.49)
8	4	TM8 ^①	53.3 (2.10)		
10	6	TM10 ^①	55.4 (2.18)	5.8 (0.23)	15.0 (0.59)
12	8	TM12 ^①	69.3 (2.73)	8.6 (0.34)	19.8 (0.78)
18	12	TM18 ^①	73.7 (2.90)	13.7 (0.54)	26.4 (1.04)
25	16	TM25	92.7 (3.65)	19.8 (0.78)	34.3 (1.35)

① ECE R110 approval available.

Female VCO O-Ring Face Seal Fittings

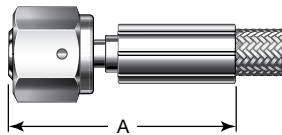

VCO Size in.	Nominal Hose Size Designator	End Connection Designator	Dimensions, in. (mm)		
			A	End Connection Inside Diameter	Maximum Outside Dimension
1/4	4	VF4	1.84 (46.7)	0.13 (3.3)	0.80 (20.3)
1/2	6	VF8	1.92 (48.8)	0.23 (5.8)	1.16 (29.5)
	8	VF8	2.18 (55.4)	0.34 (8.6)	
3/4	12	VF12	2.40 (61.0)	0.54 (13.7)	1.74 (41.2)
1	16	VF16	2.81 (71.4)	0.78 (19.8)	2.03 (51.6)

Swagelok Tube Fittings

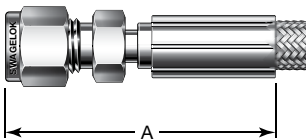

Tube Fitting Size	Nominal Hose Size Designator	End Connection Designator	Dimensions		
			A	End Connection Inside Diameter	Maximum Outside Dimension
Dimensions, in. (mm)					
1/8	4	SL2	2.00 (50.8)	0.09 (2.3)	0.51 (13.0)
1/4	4	SL4 ^①	2.10 (53.4)	0.13 (3.3)	0.66 (16.8)
3/8	6	SL6 ^①	2.27 (57.7)	0.23 (5.8)	0.80 (20.3)
1/2	8	SL8 ^①	2.64 (67.1)	0.34 (8.6)	1.02 (25.9)
3/4	12	SL12	2.74 (69.6)	0.54 (13.7)	1.30 (33.0)
Dimensions, mm (in.)					
6	4	SM6 ^①	54.1 (2.13)	3.3 (0.13)	16.8 (0.66)
10	6	SM10 ^①	57.9 (2.28)	5.8 (0.23)	22.1 (0.87)
12	8	SM12 ^①	67.1 (2.64)	8.6 (0.34)	25.9 (1.02)
18	12	SM18	69.6 (2.74)	13.7 (0.54)	34.8 (1.37)

① ECE R110 approval available.

T Series PTFE Hose

Female Pipe Threads,
NPT and ISO/BSP Tapered
(ISO 7)

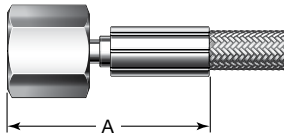

Female NPT and ISO/BSP Tapered Size in.	Nominal Hose Size Designator	End Connection Designator	Dimensions, in. (mm)		
			A	End Connection Inside Diameter	Maximum Outside Dimension
NPT					
1/4	4	PF4	1.91 (48.5)	0.13 (3.3)	0.87 (22.1)
	6	PF4	1.94 (49.3)	0.23 (5.8)	
3/8	6	PF6	2.01 (51.1)	0.23 (5.8)	1.02 (25.8)
1/2	8	PF8	2.48 (63.0)	0.34 (8.6)	1.23 (31.2)
3/4	12	PF12	2.57 (65.3)	0.54 (13.7)	1.52 (38.7)
ISO/BSP Tapered					
1/4	4	FT4	1.91 (48.5)	0.13 (3.3)	0.87 (22.1)
1/2	8	FT8	2.48 (63.0)	0.34 (8.6)	1.23 (31.2)

Male Pipe Threads,
NPT and ISO/BSP Tapered
(ISO 7)

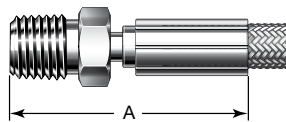

Male NPT and ISO/BSP Tapered Size in.	Nominal Hose Size Designator	End Connection Designator	Dimensions, in. (mm)		
			A	End Connection Inside Diameter	Maximum Outside Dimension
NPT					
1/4	4	PM4 ^①	1.96 (49.8)	0.13 (3.3)	0.66 (16.8)
	6	PM4 ^①	2.04 (51.8)	0.23 (5.8)	
	8	PM4	2.31 (58.7)	0.28 (7.1)	
3/8	6	PM6 ^①	2.07 (52.6)	0.23 (5.8)	0.80 (20.3)
	8	PM6 ^①	2.31 (58.7)	0.34 (8.6)	
1/2	8	PM8 ^①	2.52 (64.0)	0.34 (8.6)	1.02 (25.8)
	12	PM8	2.63 (66.8)		1.16 (29.5)
3/4	12	PM12	3.11 (79.0)	0.54 (13.7)	1.23 (31.2)
	16	PM12			1.45 (36.8)
1	16	PM16	3.32 (84.3)	0.78 (19.8)	1.60 (40.5)
ISO/BSP Tapered					
1/4	4	MT4 ^①	1.96 (49.8)	0.13 (3.3)	0.66 (16.8)
1/2	8	MT8 ^①	2.52 (64.0)	0.34 (8.6)	1.02 (25.8)
3/4	12	MT12	2.63 (66.8)	0.54 (13.7)	1.23 (31.2)
1	16	MT16	3.32 (84.3)	0.78 (19.8)	1.60 (40.5)

① ECE R110 approval available.

Female VCR Metal Gasket
Face Seal Fittings

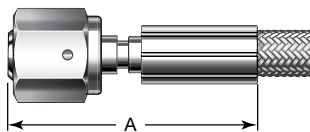

VCR Size in.	Nominal Hose Size Designator	End Connection Designator	Dimensions, in. (mm)		
			A	End Connection Inside Diameter	Maximum Outside Dimension
1/4	4	RF4	2.16 (54.9)	0.13 (3.3)	0.87 (22.1)
1/2	8	RF8	2.40 (61.0)	0.34 (8.6)	1.23 (31.2)
3/4	12	RF12	2.88 (73.2)	0.54 (13.7)	1.74 (44.2)
1	16	RF16	3.48 (88.4)	0.78 (19.8)	2.03 (51.6)

T Series PTFE Hose

SAE 37° (JIC) Male Flare

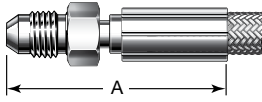

JIC Flare Size in.	Nominal Hose Size Designator	End Connection Designator	Dimensions, in. (mm)		
			A	End Connection Inside Diameter	Maximum Outside Dimension
1/4	4	AN4 ^①	1.98 (50.3)	0.13 (3.3)	0.59 (15.0)
3/8	6	AN6 ^①	2.05 (52.1)	0.23 (5.8)	0.73 (18.5)
1/2	8	AN8 ^①	2.43 (61.7)	0.34 (8.6)	0.94 (23.9)

① ECE R110 approval available.

SAE 37° (JIC) Female Swivel

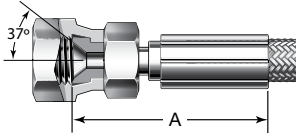

JIC Swivel Size in.	Nominal Hose Size Designator	End Connection Designator	Dimensions, in. (mm)		
			A	End Connection Inside Diameter	Maximum Outside Dimension
1/4	4	AS4	1.60 (40.6)	0.13 (3.3)	0.73 (18.5)
3/8	6	AS6	1.67 (42.4)	0.23 (5.8)	0.87 (22.1)
1/2	8	AS8	1.93 (49.0)	0.34 (8.6)	1.09 (27.7)

Sanitary Kwik-Clamps

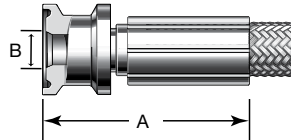

Kwik-Clamp Size in.	Nominal Hose Size Designator	End Connection Designator	Dimensions, in. (mm)			
			A	End Connection Inside Diameter	Maximum Outside Dimension	B, Flange Face Inside Diameter
1/2	8	KC8	2.28 (57.9)	0.34 (8.6)	0.99 (25.1)	0.37 (9.4)
3/4	12	KC12	2.20 (55.9)	0.54 (13.7)	1.04 (26.4)	0.62 (15.7)
1	16	KC16	2.64 (67.0)	0.78 (19.8)	1.98 (50.3)	0.87 (22.1)
1 1/2	16	KC24	2.48 (63.0)			1.37 (34.8)

Working pressure and temperature ratings of hoses with sanitary Kwik-Clamp end connections may be limited by the gasket material and clamp. Maximum pressure rating is 300 psig (20.6 bar).

B Series PTFE Hose

Features

- General purpose PTFE hose.
- Smooth-bore PTFE core.
- 1/8 in. size and working pressure of 3000 psig (206 bar).
- 304 stainless steel braid ensures hose pressure containment and protects the core from abrasion.
- PTFE material complies with FDA regulation 21CFR Part 177.1550 and USP <88> Class VI, and is free of TSE, BSE, and ADI as defined in EMEA/410/01.
- Commonly used where chemical compatibility is desired.
- Custom hose lengths and end connections available.
- Options include hose covers, hose tags, and additional cleaning. See page 107 for details.
- For electrical properties, see page 5 for details.

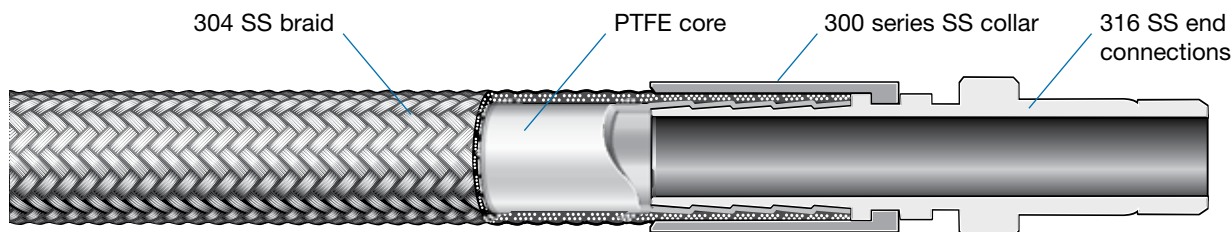

Technical Data

Nominal Hose Size in. (mm)	Inside Diameter in. (mm)	Outside Diameter in. (mm)	Minimum Inside Bend Radius in. (cm)		Temperature Range °F (°C)	Vacuum (28.5 in.Hg [96.5 kPa]) Rated to ... °F (°C)	Working Pressure at -65 to 450°F (-53 to 230°C) psig (bar)	Minimum Burst Pressure at 70°F (20°C) psig (bar)	Bulk Hose Weight lb/ft (kg/m)
			Static	Dynamic					
1/8 (3.2)	0.125 (3.2)	0.25 (6.4)	1.50 (3.81)	3.75 (9.52)	-65 to 450 (-53 to 230)	450 (230)	3000 (206)	12 000 (826)	0.05 (0.07)

Pressure-temperature ratings may be limited by the end connections.

Pressure-Temperature Ratings

Temperature °F (°C)	Working Pressure psig (bar)
-65 (-53) to 450 (230)	3000 (206)

Testing

Every Swagelok B series hose assembly is pressure tested with water at room temperature for 30 seconds to a requirement of no detectable leakage. Testing is performed at a minimum of 1000 psig (69 bar), or 225 psig (15.5 bar) if an end connection is rated below 1000 psig (69 bar).

Cleaning and Packaging

Every Swagelok B series hose component is cleaned in accordance with Swagelok *Standard Cleaning and Packaging (SC-10)* catalog, [MS-06-62](#).

B Series PTFE Hose

Ordering Information

Custom Hose Assemblies

Build a hose assembly ordering number by combining the designators in the sequence shown below.



Typical Ordering Number

1 2 3 4 4 5 6 5 6
 SS - BT 2 TA2 PM2 - 28 - MB or 71 CM - MB
in. cm

1 Material

End Connections

SS = 316 stainless steel
 HC = Alloy C-276

2 Hose

BT = B series PTFE hose

3 Nominal Hose Size, in.

2 = 1/8

4 End Connections

See **End Connection Designator** column in tables on pages 73 to 82

5 Overall Length

Inches or centimeters, in whole numbers. Include **CM** as shown for centimeter lengths.

Typical maximum one-piece hose length is 900 in. or 2286 cm. Longer assemblies may be spliced; specify splices under **Options**. See page 4 for more information about splices.

6 Options

For multiple options, add designators with a dash between each designator.

C = ASTM G93 Level C cleaning on hose wetted surfaces

F = Fire jacket

W = Hydrostatic test

Splices

SP1 = 1 splice

SP2 = 2 splices

Mat Tags

MA = Gray

MO = Orange

MB = Blue

MP = Purple

MC = Brown

MR = Red

MG = Green

MW = White

MK = Black

MY = Yellow

MN = Pink

Add **2** to the end of the Mat Tag designator for two tags.

Example: MA2

Other Tags

T = Lanyard tag

T2 = Two lanyard tags

T5 = Clamp tag

Specify text for tags. see **Hose Tag Text** table, page 109.

See page 107 for detailed descriptions of options.

X Series PTFE Hose

Features

- Highly flexible PTFE hose.
- Smooth-bore PTFE core.
- Size range of 1/4 through 1 in. and working pressures up to 3500 psig (241 bar).
- Fiber braid bonded to the core with a patent-pending process supports core to resist kinking.
- 304 stainless steel braid protects the core from abrasion and enhances hose pressure rating.
- PTFE material complies with FDA regulation 21CFR Part 177.1550 and USP <88> Class VI, and is free of TSE, BSE, and ADI as defined in EMEA/410/01.
- Optional carbon black-filled PTFE core is available for applications that require static dissipation.
- Commonly used where flexibility and chemical compatibility are desired.
- Custom hose lengths and end connections available.
- Options include hose covers, hose tags, and additional cleaning. See page 107 for details.
- For electrical properties, see page 5 for details.

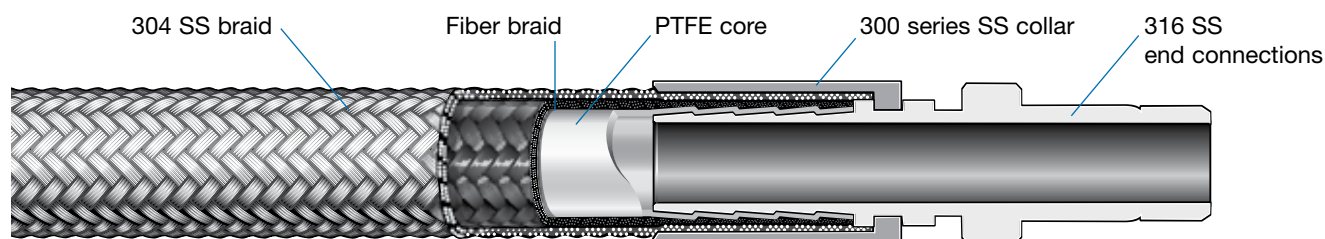

Technical Data

Nominal Hose Size in. (mm)	Inside Diameter in. (mm)	Outside Diameter in. (mm)	Minimum Inside Bend Radius in. (cm)		Temperature Range °F (°C)	Vacuum (28.5 in.Hg [96.5 kPa]) Rated to ... °F (°C)	Working Pressure at 70°F (20°C) psig (bar)	Minimum Burst Pressure at 70°F (20°C) psig (bar)	Bulk Hose Weight lb/ft (kg/m)
			Static	Dynamic					
1/4 (6.4)	0.25 (6.4)	0.46 (11.7)	1.25 (3.18)	4.20 (10.7)	-65 to 450 (-53 to 230)	450 (230)	3500 (241)	14 000 (964)	0.13 (0.19)
3/8 (9.6)	0.38 (9.6)	0.57 (14.5)	1.75 (4.44)	4.40 (11.2)		450 (230)	3000 (206)	12 000 (826)	0.17 (0.25)
1/2 (12.7)	0.50 (12.7)	0.76 (19.3)	2.50 (6.35)	4.55 (11.6)		450 (230)	1800 (124)	7 200 (496)	0.24 (0.36)
3/4 (19.0)	0.75 (19.0)	1.00 (25.4)	3.50 (8.89)	6.38 (16.2)	-100 to 450 (-73 to 230)	200 (93)	1250 (86.1)	5 000 (344)	0.36 (0.54)
1 (25.4) ^①	1.00 (25.4)	1.32 (33.5)	5.50 (14.0)	7.15 (18.2)		150 (65)	1000 (68.9)	4 000 (275)	1.1 (1.6)

Pressure-temperature ratings may be limited by the end connections.

① Constructed with two stainless steel braids and no fiber braid reinforcement.

Pressure-Temperature Ratings

Nominal Hose Size, in.	1/4	3/8	1/2	3/4	1
Temperature, °F (°C)	Working Pressure, psig (bar)				
-100 (-73) to -65 (-53)	—	—	150 (10.3)	150 (10.3)	150 (10.3)
-65 (-53) to 100 (37)	3500 (241)	3000 (206)	1800 (124)	1250 (86.1)	1000 (68.9)
200 (93)	3500 (241)	2345 (161)	1800 (124)	1135 (78.2)	1000 (68.9)
300 (148)	3460 (238)	1965 (135)	1790 (123)	1010 (69.5)	895 (61.6)
400 (204)	3265 (224)	1810 (124)	1665 (114)	900 (62.0)	895 (61.6)
450 (230)	3205 (220)	1675 (115)	1665 (114)	900 (62.0)	895 (61.6)

X Series PTFE Hose

Testing

Every Swagelok X series hose assembly is pressure tested with water at room temperature for 30 seconds to a requirement of no detectable leakage. Testing is performed at 1000 psig (69 bar), or 225 psig (15.5 bar) if an end connection is rated below 1000 psig (69 bar).

Ordering Information

Custom Hose Assemblies

Build a hose assembly ordering number by combining the designators in the sequence shown below.



Typical Ordering Number

1 2 3 4 4 5 6 5 6 7
SS - XT 8 TA 8 KC 16 - 28 - MB or **71 CM - MB**
in. cm

1 Material

End Connections

SS = 316 stainless steel
 B = Brass (only on 1/4 in. PM, PF, and 1/4 in. hose size)
 HC = Alloy C-276

2 Hose

XT = X series PTFE hose
 XC = X series carbon black-filled PTFE hose

3 Nominal Hose Size, in.

4 = 1/4
 6 = 3/8
 8 = 1/2
 12 = 3/4
 16 = 1

4 End Connections

See **End Connection Designator** column in tables on pages 73 to 82.

5 Overall Length

Inches or centimeters, in whole numbers. Include **CM** as shown for centimeter lengths.

Typical maximum one-piece hose length:

- 900 in. or 2286 cm for 1/4 through 1/2 in. hose
- 600 in. or 1524 cm for 3/4 and 1 in. hose.

Longer assemblies may be spliced; specify splices under **Options**. See page 4 for more information about splices.

6 Options

For multiple options, add designators with a dash between each designator.

- A = Armor guard
- C = ASTM G93 Level C cleaning on hose wetted surfaces
- F = Fire jacket
- G6 = Spiral guard, black
- G7 = Spiral guard, blue
- G8 = Spiral guard, yellow
- W = Hydrostatic test

Splices

SP1 = 1 splice
 SP2 = 2 splices

Mat Tags

MA = Gray	MO = Orange
MB = Blue	MP = Purple
MC = Brown	MR = Red
MG = Green	MW = White
MK = Black	MY = Yellow
MN = Pink	

Add **2** to the end of the Mat Tag designator for two tags. Example: MA2

Other Tags

T = Lanyard tag
 T2 = Two lanyard tags
 T5 = Clamp tag

Specify text for tags. see **Hose Tag Text** table, page 109.

See page 107 for detailed descriptions of options.

7 Two Elbow Orientation

Only include a value in the assembly number when both end connections are elbows. See page 76 for values and further information.

S Series PTFE Hose

Features

- Highly flexible, silicone-covered PTFE hose.
- Smooth-bore PTFE core.
- Size range of 1/8 through 1 in. and working pressures up to 3500 psig (241 bar).
- Fiber braid bonded to the core with a patent-pending process supports core to resist kinking.
- 304 stainless steel braid protects the core from abrasion and enhances hose pressure rating.
- Silicone cover provides smooth, noncontaminating, easy-to-clean surface and insulation from internal system fluid temperature extremes.
- PTFE material complies with FDA regulation 21CFR Part 177.1550, USP <88> Class VI (121°C), 3-A (for hose sizes 3/4 and 1 in.), and is free of TSE, BSE, and ADI as defined in EMEA/410/01.
- Optional carbon black-filled PTFE core is available for applications that require static dissipation.
- Commonly used where flexibility and chemical compatibility are desired.
- Custom hose lengths and end connections available.
- Options include hose covers, hose tags, and additional cleaning. See page 107 for details.
- For electrical properties, see page 5 for details.

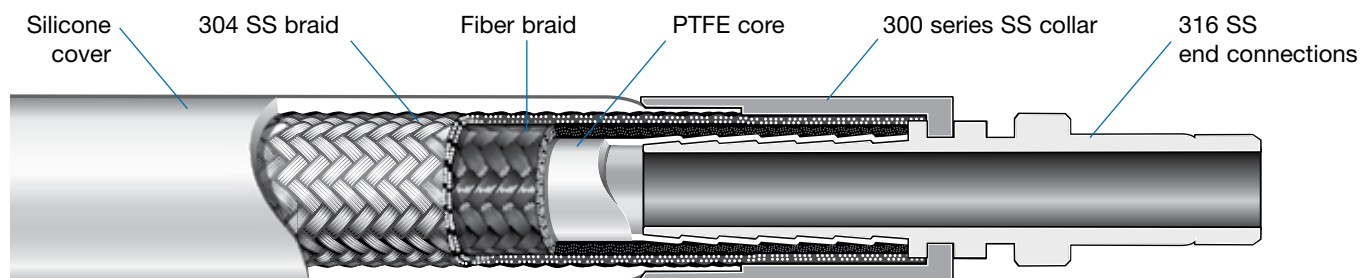

Technical Data

Nominal Hose Size in. (mm)	Inside Diameter in. (mm)	Outside Diameter in. (mm)	Minimum Inside Bend Radius in. (cm)		Temperature Range °F (°C)	Vacuum (28.5 in.Hg [96.5 kPa]) Rated to ... °F (°C)	Working Pressure at 70°F (20°C) psig (bar)	Minimum Burst Pressure at 70°F (20°C) psig (bar)	Bulk Hose Weight lb/ft (kg/m)
			Static	Dynamic					
1/8 (3.2) ^①	0.125 (3.2)	0.42 (10.7)	1.50 (3.81)	3.75 (9.52)	-65 to 400 (-53 to 204)	400 (204)	3000 (206)	12 000 (826)	0.09 (0.13)
1/4 (6.4)	0.25 (6.4)	0.55 (14.0)	1.25 (3.18)	4.20 (10.7)		400 (204)	3500 (241)	14 000 (964)	0.19 (0.28)
3/8 (9.6)	0.38 (9.6)	0.71 (18.0)	1.75 (4.44)	4.40 (11.2)		400 (204)	3000 (206)	12 000 (826)	0.25 (0.37)
1/2 (12.7)	0.50 (12.7)	0.86 (21.8)	2.50 (6.35)	4.55 (11.6)		400 (204)	1800 (124)	7 200 (496)	0.34 (0.51)
3/4 (19.0)	0.75 (19.0)	1.12 (28.4)	3.50 (8.89)	6.38 (16.2)		200 (93)	1250 (86.1)	5 000 (344)	0.47 (0.70)
1 (25.4) ^②	1.00 (25.4)	1.55 (39.4)	5.50 (14.0)	7.15 (18.2)		150 (65)	1000 (68.9)	4 000 (275)	1.8 (2.7)

Pressure-temperature ratings may be limited by the end connections.

① Constructed with no fiber braid reinforcement.

② Constructed with two stainless steel braids and no fiber braid reinforcement.

Pressure-Temperature Ratings

Nominal Hose Size, in.	1/8	1/4	3/8	1/2	3/4	1
Temperature, °F (°C)	Working Pressure, psig (bar)					
-65 (-53) to 100 (37)	3000 (206)	3500 (241)	3000 (206)	1800 (124)	1250 (86.1)	1000 (68.9)
200 (93)	3000 (206)	3500 (241)	2650 (182)	1800 (124)	1250 (86.1)	1000 (68.9)
300 (148)	2610 (179)	3435 (236)	2510 (172)	1800 (124)	1250 (86.1)	1000 (68.9)
400 (204)	2550 (175)	3320 (228)	2495 (171)	1800 (124)	1250 (86.1)	1000 (68.9)

C Series PTFE Hose

Features

- Low-weight, highly flexible PTFE hose.
- Helical convoluted bore PTFE core.
- Size range of 1/2 through 2 in. and working pressures up to 1500 psig (103 bar).
- 300 series stainless steel braid ensures hose pressure containment and protects the core from abrasion.
- PTFE material complies with FDA regulation 21CFR Part 177.1550 and USP <88> Class VI, and is free of TSE, BSE, and ADI as defined in EMEA/410/01.
- Optional carbon black-filled PTFE core is available for applications that require static dissipation.
- Commonly used where high flexibility and chemical compatibility are desired.
- Custom hose lengths and end connections available.
- Options include hose covers, hose tags, and additional cleaning. See page 107 for details.
- For electrical properties, see page 5 for details.

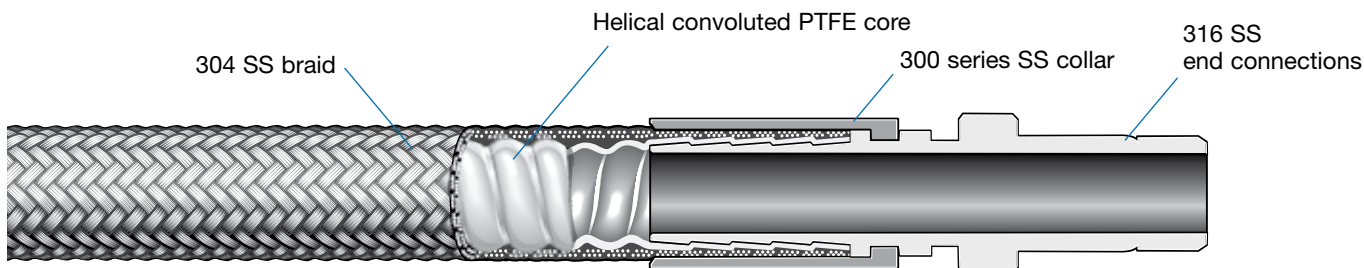

Technical Data

Nominal Hose Size in. (mm)	Inside Diameter in. (mm)	Outside Diameter in. (mm)	Minimum Inside Bend Radius in. (cm)		Temperature Range °F (°C)	Vacuum (28.5 in.Hg [96.5 kPa]) Rated to ... °F (°C)	Working Pressure at 70°F (20°C) psig (bar)	Minimum Burst Pressure at 70°F (20°C) psig (bar)	Bulk Hose Weight lb/ft (kg/m)
			Static	Dynamic					
1/2 (12.7)	0.50 (12.7)	0.76 (19.3)	2.50 (6.35)	3.75 (9.52)	-65 to 450 (-53 to 230)	450 (230)	1500 (103)	6000 (413)	0.20 (0.30)
3/4 (19.0)	0.75 (19.0)	1.00 (25.4)	3.00 (7.62)	3.90 (9.91)		450 (230)	1100 (75.7)	4400 (303)	0.28 (0.42)
1 (25.4)	1.00 (25.4)	1.32 (33.5)	5.50 (14.0)	7.15 (18.2)		200 (93)	750 (51.6)	3000 (206)	0.47 (0.70)
1 1/2 (38.1)	1.50 (38.1)	2.03 (51.6)	6.00 (15.2)	7.80 (19.8)	-20 to 340 (-28 to 171)	150 (65)	700 (48.2)	2800 (192)	0.83 (1.2)
2 (50.8)	2.00 (50.8)	2.54 (64.5)	7.50 (19.0)	9.75 (24.8)		—	525 (36.1)	2100 (144)	1.02 (1.5)

Pressure-temperature ratings may be limited by the end connections.

Pressure-Temperature Ratings

Nominal Hose Size, in.	1/2 ^①	3/4 ^①	1 ^①	1 1/2 ^①	2 ^①
Temperature, °F (°C)	Working Pressure, psig (bar)				
-65 (-53)	1500 (103)	1100 (75.7)	750 (51.6)	—	—
-20 (-28)	1500 (103)	1100 (75.7)	750 (51.6)	675 (46.5)	525 (36.1)
0 (-17) to 100 (37)	1500 (103)	1100 (75.7)	750 (51.6)	700 (48.2)	525 (36.1)
200 (93)	1500 (103)	1100 (75.7)	700 (48.2)	435 (29.9)	525 (36.1)
300 (148)	1500 (103)	1100 (75.7)	620 (42.7)	405 (27.9)	495 (34.1)
340 (171)	1500 (103)	1030 (70.9)	600 (41.3)	330 (22.7)	485 (33.4)
400 (204)	1500 (103)	960 (66.1)	565 (38.9)	—	—
450 (230)	1500 (103)	900 (62.0)	490 (33.7)	—	—

① Hose with carbon black-filled PTFE core (CC series) is limited to 340°F (171°C).

C Series PTFE Hose

Testing

Every Swagelok C series hose assembly is pressure tested with water at room temperature for 30 seconds to a requirement of no detectable leakage.

- For hose assemblies 1 in. and under, testing is performed at 1000 psig (69 bar), or 225 psig (15.5 bar) if an end connection is rated below 1000 psig (69 bar).

- For hose assemblies over 1 in., testing is performed at 500 psig (34.4 bar), or 225 psig (15.5 bar) if an end connection is rated below 500 psig (34.4 bar).

Cleaning and Packaging

Every Swagelok C series hose component is cleaned in accordance with Swagelok *Standard Cleaning and Packaging* (SC-10) catalog, [MS-06-62](#).

Ordering Information

Custom Hose Assemblies

Build a hose assembly ordering number by combining the designators in the sequence shown below.



Typical Ordering Number

1 2 3 4 4 5 6 5 6 7
SS - CT 8 TA 8 KC 16 - 28 - MB or **71 CM - MB**
in. cm

1 Material

End Connections

- SS = 316 stainless steel
- HC = Alloy C-276

2 Hose

- CT = C series helical convoluted PTFE hose
- CC = C series convoluted, carbon black-filled PTFE hose

3 Nominal Hose Size, in.

- 8 = 1/2
- 12 = 3/4
- 16 = 1
- 24 = 1 1/2
- 32 = 2

4 End Connections

See **End Connection Designator** column in tables on pages 73 to 82.

5 Overall Length

Inches or centimeters, in whole numbers. Include **CM** as shown for centimeter lengths.

Typical maximum one-piece hose length:

- 900 in. or 2286 cm for 1/2 in. hose
- 600 in. or 1524 cm for 3/4 and 1 in. hose
- 300 in. or 762 cm for 1 1/2 and 2 in. hose.

Longer assemblies may be spliced; specify splices under **Options**. See page 4 for more information about splices.

6 Options

For multiple options, add designators with a dash between each designator.

- A = Armor guard
- C = ASTM G93 Level C cleaning on hose wetted surfaces
- F = Fire jacket
- G6 = Spiral guard, black
- G7 = Spiral guard, blue
- G8 = Spiral guard, yellow
- W = Hydrostatic test

Splices

- SP1 = 1 splice
- SP2 = 2 splices

Mat Tags

- MA = Gray
- MB = Blue
- MC = Brown
- MG = Green
- MK = Black
- MN = Pink
- MO = Orange
- MP = Purple
- MR = Red
- MW = White
- MY = Yellow

Add 2 to the end of the Mat Tag designator for two tags.

Example: MA2

Other Tags

- T = Lanyard tag
- T2 = Two lanyard tags
- T5 = Clamp tag

Specify text for tags. see **Hose Tag Text** table, page 109.

See page 107 for detailed descriptions of options.

7 Two Elbow Orientation

Only include a value in the assembly number when both end connections are elbows. See page 76 for values and further information.

J Series PTFE Hose

Features

- Low-weight, highly flexible PTFE hose.
- Helical convoluted bore PTFE core.
- Size range of 1/2 through 1 in. and working pressures up to 1500 psig (103 bar).
- 300 series stainless steel braid ensures hose pressure containment and protects the core from abrasion.
- Silicone cover provides smooth, noncontaminating, easy-to-clean surface and insulation from internal system fluid temperature extremes.
- PTFE material complies with FDA regulation 21CFR Part 177.1550, USP <88> Class VI, 3-A (for hose sizes 3/4 and 1 in.), and is free of TSE, BSE, and ADI as defined in EMEA/410/01.
- Commonly used where high flexibility and chemical compatibility are desired.
- Custom hose lengths and end connections available.
- Options include hose covers, hose tags, and additional cleaning. See page 107 for details.
- For electrical properties, see page 5 for details.

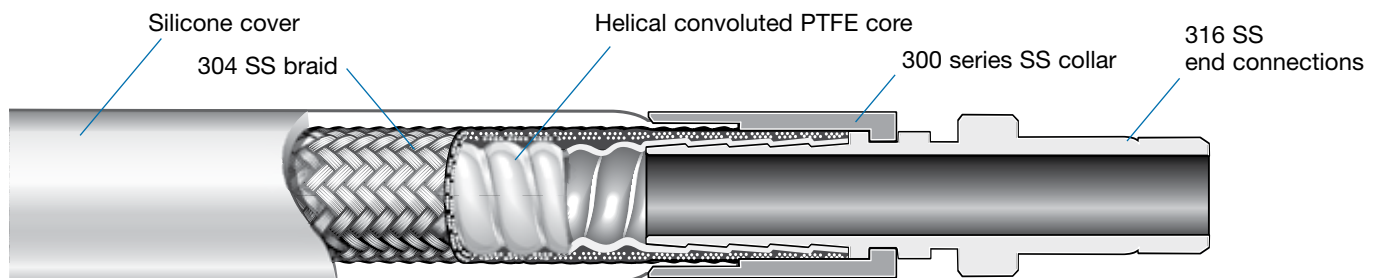

Technical Data

Nominal Hose Size in. (mm)	Inside Diameter in. (mm)	Outside Diameter in. (mm)	Minimum Inside Bend Radius in. (cm)		Temperature Range °F (°C)	Vacuum (28.5 in.Hg [96.5 kPa]) Rated to ... °F (°C)	Working Pressure at 70°F (20°C) psig (bar)	Minimum Burst Pressure at 70°F (20°C) psig (bar)	Bulk Hose Weight lb/ft (kg/m)
			Static	Dynamic					
1/2 (12.7)	0.50 (12.7)	0.88 (22.4)	2.50 (6.35)	3.75 (9.52)	-65 to 400 (-53 to 204)	400 (204)	1500 (103)	6000 (413)	0.28 (0.42)
3/4 (19.0)	0.75 (19.0)	1.12 (28.4)	3.00 (7.62)	3.90 (9.91)		400 (204)	1100 (75.7)	4400 (303)	0.40 (0.60)
1 (25.4)	1.00 (25.4)	1.47 (37.3)	5.50 (14.0)	7.15 (18.2)		200 (93)	750 (51.6)	3000 (206)	0.72 (1.1)

Pressure-temperature ratings may be limited by the end connections.

Pressure-Temperature Ratings

Nominal Hose Size, in.	1/2	3/4	1
Temperature, °F (°C)	Working Pressure, psig (bar)		
-65 (-53)	1500 (103)	1100 (75.7)	750 (51.6)
-20 (-28)	1500 (103)	1100 (75.7)	750 (51.6)
0 (-17) to 100 (37)	1500 (103)	1100 (75.7)	750 (51.6)
200 (93)	1500 (103)	1100 (75.7)	750 (51.6)
300 (148)	1500 (103)	1095 (75.4)	620 (42.7)
340 (171)	1500 (103)	1075 (74.0)	595 (40.9)
400 (204)	1500 (103)	1050 (72.3)	555 (38.2)
450 (230)	—	—	—

J Series PTFE Hose

Testing

Every Swagelok J series hose assembly is pressure tested with water at room temperature for 30 seconds to a requirement of no detectable leakage.

- Testing is performed at 1000 psig (69 bar), or 225 psig (15.5 bar) if an end connection is rated below 1000 psig (69 bar).

Cleaning and Packaging

Every Swagelok J series hose component is cleaned in accordance with Swagelok *Standard Cleaning and Packaging (SC-10)* catalog, [MS-06-62](#).

Ordering Information

Custom Hose Assemblies

Build a hose assembly ordering number by combining the designators in the sequence shown below.



Typical Ordering Number

1 2 3 4 4 5 6 5 6 7
SS - JT 8 TA 8 KC 16 - 28 - MB or **71 CM - MB**
in. cm

1 Material

End Connections

SS = 316 stainless steel
 HC = Alloy C-276

2 Hose

JT = J series helical convoluted PTFE hose with silicone cover

3 Nominal Hose Size, in.

8 = 1/2
 12 = 3/4
 16 = 1

4 End Connections

See **End Connection Designator** column in tables on pages 73 to 82.

5 Overall Length

Inches or centimeters, in whole numbers. Include **CM** as shown for centimeter lengths.

Typical maximum one-piece hose length:

- 900 in. or 2286 cm for 1/2 in. hose
- 600 in. or 1524 cm for 3/4 and 1 in. hose

Longer assemblies may be spliced; specify splices under **Options**. See page 4 for more information about splices.

6 Options

For multiple options, add designators with a dash between each designator.

A = Armor guard
 C = ASTM G93 Level C cleaning on hose wetted surfaces
 F = Fire jacket
 G6 = Spiral guard, black
 G7 = Spiral guard, blue
 G8 = Spiral guard, yellow
 W = Hydrostatic test

Splices

SP1 = 1 splice
 SP2 = 2 splices

Mat Tags

MA = Gray MO = Orange
 MB = Blue MP = Purple
 MC = Brown MR = Red
 MG = Green MW = White
 MK = Black MY = Yellow
 MN = Pink

Add 2 to the end of the Mat Tag designator for two tags.

Example: MA2

Perma Tags

PA = Gray PO = Orange
 PB = Blue PP = Purple
 PC = Brown PR = Red
 PG = Green PW = White
 PK = Black PY = Yellow
 PN = Pink

Add 2 to the end of the Perma Tag designator for two tags.

Example: PA2

6 Options

Other Tags

T = Lanyard tag
 T2 = Two lanyard tags

Specify text for tags. see **Hose Tag Text** table, page 109.

See page 107 for detailed descriptions of options.

7 Two Elbow Orientation

Only include a value in the assembly number when both end connections are elbows. See page 76 for values and further information.

N Series PTFE Hose

Features

- Nonmetallic PTFE hose.
- Helical convoluted bore, carbon black-filled PTFE core for applications that require static dissipation.
- 3/8, 1/2, and 3/4 in. sizes and working pressures up to 1250 psig (86.1 bar).
- Internal insulating wrap eliminates need for external insulation in many applications.
- Aramid fiber braid aids pressure containment and maintains flexibility while reducing weight.
- PTFE material complies with FDA regulation 21CFR Part 177.1550, USP <88> Class VI, and is free of TSE, BSE, and ADI as defined in EMEA/410/01.
- Commonly used where flexibility, chemical compatibility, and a nonconductive braid are desired.
- Custom hose lengths and end connections available.
- Options include hose covers, hose tags, and additional cleaning. See page 107 for details.
- For electrical properties, see page 5 for details.

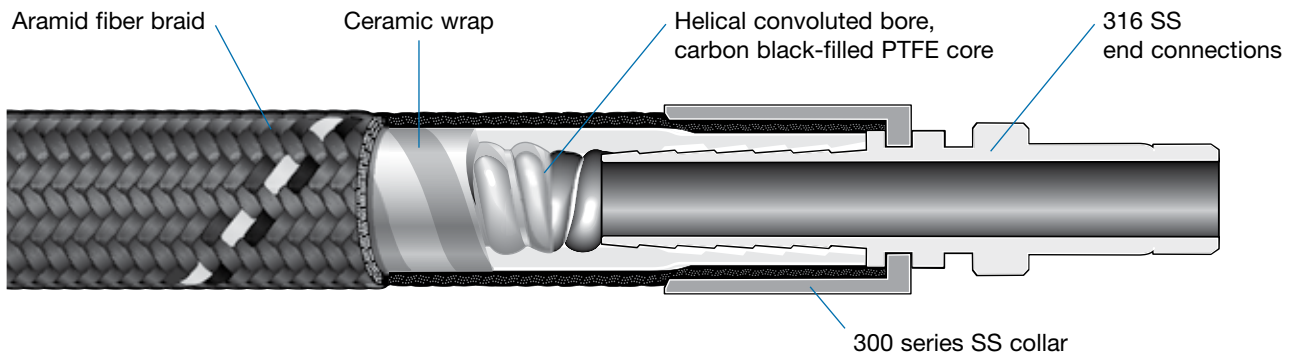

Technical Data

Nominal Hose Size in. (mm)	Inside Diameter in. (mm)	Outside Diameter in. (mm)	Minimum Inside Bend Radius in. (cm)		Temperature Range °F (°C)	Vacuum (28.5 in.Hg [96.5 kPa]) Rated to ... °F (°C)	Working Pressure at 70°F (20°C) psig (bar)	Minimum Burst Pressure at 70°F (20°C) psig (bar)	Bulk Hose Weight lb/ft (kg/m)
			Static	Dynamic					
3/8 (9.6)	0.37 (9.4)	0.70 (17.8)	2.50 (6.35)	4.00 (10.2)	-65 to 450 (-53 to 230)	450 (230)	1250 (86.1)	5000 (344)	0.12 (0.18)
1/2 (12.7)	0.51 (13.0)	0.86 (21.8)	3.50 (8.89)	5.25 (13.3)		400 (204)	750 (51.6)	3000 (206)	0.15 (0.22)
3/4 (19.0)	0.75 (19.0)	1.12 (28.4)	4.50 (11.4)	5.85 (14.9)		—	375 (25.8)	1500 (103)	0.19 (0.28)

Pressure-temperature ratings may be limited by the end connections.

Pressure-Temperature Ratings

Nominal Hose Size, in.	3/8	1/2	3/4
Temperature, °F (°C)	Working Pressure, psig (bar)		
-65 (-53)	1250 (86.1)	720 (49.6)	375 (25.8)
0 (-17) to 100 (37)	1250 (86.1)	750 (51.6)	375 (25.8)
200 (93)	500 (34.4)	340 (23.4)	275 (18.9)
300 (148)	365 (25.1)	235 (16.1)	165 (11.3)
400 (204)	165 (11.3)	160 (11.0)	85.0 (5.8)
450 (230)	140 (9.6)	130 (8.9)	80.0 (5.5)

W Series PTFE Hose

Features

- Silicone covered PTFE hose.
- Smooth-bore, carbon black-filled PTFE core for applications that require static dissipation.
- 3/8, 1/2, and 3/4 in. sizes and working pressures up to 750 psig (51.6 bar).
- Fiber braid bonded to the core with a patent-pending process supports core to reduce kinking.
- 304 stainless steel braid ensures hose pressure containment and protects the core from abrasion.
- Silicone cover provides smooth, noncontaminating, easy-to-clean surface and insulation from internal system fluid temperature extremes; cover is available in black, blue, red, and white.
- PTFE material complies with FDA regulation 21CFR Part 177.1550, USP <88> Class VI, 3-A (for hose size 3/4 in.), and is free of TSE, BSE, and ADI as defined in EMEA/410/01.
- Commonly used where flexibility, chemical compatibility, and exterior insulating (hot/cold) cover are desired.
- Custom hose lengths and end connections available.
- Options include hose covers, hose tags, and additional cleaning. See page 107 for details.
- For electrical properties, see page 5 for details.

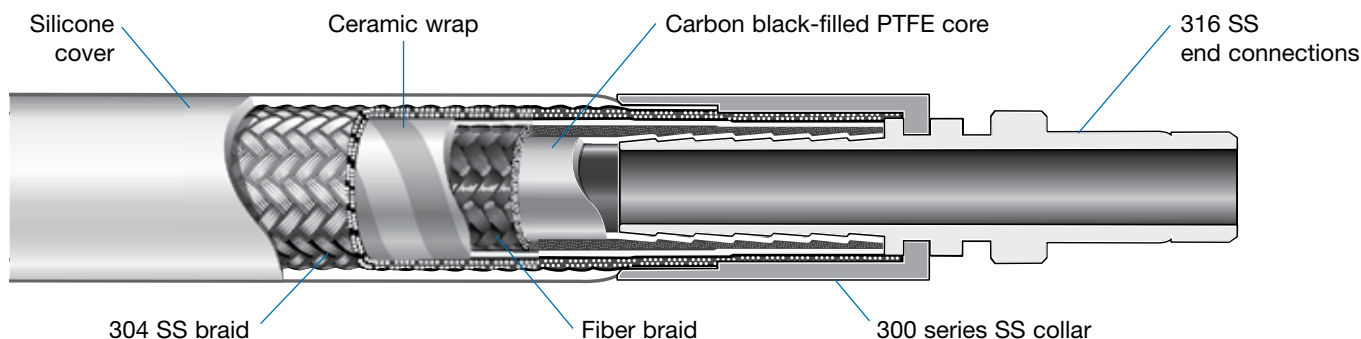

Technical Data

Nominal Hose Size in. (mm)	Inside Diameter in. (mm)	Outside Diameter in. (mm)	Minimum Inside Bend Radius in. (cm)		Temperature Range °F (°C)	Vacuum (28.5 in.Hg [96.5 kPa]) Rated to ... °F (°C)	Working Pressure at 70°F (20°C) psig (bar)	Minimum Burst Pressure at 70°F (20°C) psig (bar)	Bulk Hose Weight lb/ft (kg/m)
			Static	Dynamic					
3/8 (9.6)	0.35 (8.9)	0.75 (19.0)	2.75 (6.98)	4.40 (11.2)	-65 to 400 (-53 to 204)	400 (204)	750 (51.6)	3000 (206)	0.29 (0.43)
1/2 (12.7)	0.50 (12.7)	0.92 (23.4)	4.25 (10.8)	6.38 (16.2)		200 (93)	750 (51.6)	3000 (206)	0.35 (0.52)
3/4 (19.0)	0.75 (19.0)	1.19 (30.2)	6.75 (17.1)	8.00 (20.3)		—	500 (34.4)	2000 (137)	0.50 (0.74)

Pressure-temperature ratings may be limited by the end connections.

Pressure-Temperature Ratings

Nominal Hose Size, in.	3/8, 1/2	3/4
Temperature, °F (°C)	Working Pressure, psig (bar)	
-65 (-53) to 400 (204)	750 (51.6)	500 (34.4)

W Series PTFE Hose

Testing

Every Swagelok W series hose assembly is pressure tested with water at room temperature for 30 seconds to a requirement of no detectable leakage.

Testing is performed at 500 psig (34.4 bar), or 225 psig (15.5 bar) if an end connection is rated below 500 psig (34.4 bar).

Cleaning and Packaging

Every Swagelok W series hose component is cleaned in accordance with Swagelok *Standard Cleaning and Packaging* (SC-10) catalog, [MS-06-62](#).

Ordering Information

Custom Hose Assemblies

Build a hose assembly ordering number by combining the designators in the sequence shown below.



Typical Ordering Number

1 2 3 4 4 5 6 7 5 6 7 8
SS - WC 8 TA 8 KC 16 - 28 - BL - PG or **7 1 CM - BL PG**
in. cm

1 Material

End Connections

SS = 316 stainless steel
 HC = Alloy C-276

2 Hose

WC = W series carbon black-filled PTFE hose with silicone-cover and ceramic wrap

3 Nominal Hose Size, in.

6 = 3/8
 8 = 1/2
 12 = 3/4

4 End Connections

See **End Connection Designator** column in tables on pages 73 to 82.

5 Overall Length

Inches or centimeters, in whole numbers. Include **CM** as shown for centimeter lengths.

Typical maximum one-piece hose length is 300 in. or 762 cm. Longer assemblies may be spliced; specify splices under **Options**. See page 4 for more information about splices.

6 Silicone Cover Color

BK = Black
 BL = Blue
 RD = Red
 WH = White

3/4 in. available with blue and red only.

7 Options

For multiple options, add designators with a dash between each designator.

A = Armor guard
 C = ASTM G93 Level C cleaning on hose wetted surfaces
 F = Fire jacket
 G6 = Spiral guard, black
 G7 = Spiral guard, blue
 G8 = Spiral guard, yellow
 W = Hydrostatic test

Splices

SP1 = 1 splice
 SP2 = 2 splices

Mat Tags

MA = Gray MO = Orange
 MB = Blue MP = Purple
 MC = Brown MR = Red
 MG = Green MW = White
 MK = Black MY = Yellow
 MN = Pink

Add **2** to the end of the Mat Tag designator for two tags.

Example: MA2

Perma Tags

PA = Gray PO = Orange
 PB = Blue PP = Purple
 PC = Brown PR = Red
 PG = Green PW = White
 PK = Black PY = Yellow
 PN = Pink

Add **2** to the end of the Perma Tag designator for two tags.

Example: PA2

Other Tags

T = Lanyard tag
 T2 = Two lanyard tags

Specify text for tags. see **Hose Tag Text** table, page 109.

See page 107 for detailed descriptions of options.

8 Two Elbow Orientation

Only include a value in the assembly number when both end connections are elbows. See page 76 for values and further information.

F Series PTFE Hose

Features

- Nonmetallic PTFE hose.
- Smooth-bore PTFE core.
- Size range of 1/4 through 3/4 in. and working pressures up to 800 psig (55.1 bar).
- Fiber braid bonded to the core with a patent-pending process supports core to resist kinking.
- PTFE material complies with FDA regulation 21CFR Part 177.1550, USP <88> Class VI, and is free of TSE, BSE, and ADI as defined in EMEA/410/01.
- Optional carbon black-filled PTFE core is available for applications that require static dissipation.
- Commonly used where flexibility, chemical compatibility, and a nonconductive braid are desired.
- Custom hose lengths and end connections available.
- Options include hose covers, hose tags, and additional cleaning. See page 107 for details.
- For electrical properties, see page 5 for details.

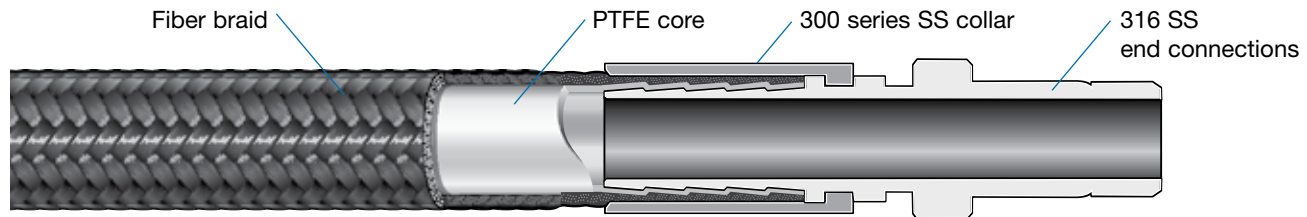

Technical Data

Nominal Hose Size in. (mm)	Inside Diameter in. (mm)	Outside Diameter in. (mm)	Minimum Inside Bend Radius in. (cm)		Temperature Range °F (°C)	Working Pressure at 70°F (20°C) psig (bar)	Minimum Burst Pressure at 70°F (20°C) psig (bar)	Bulk Hose Weight lb/ft (kg/m)
			Static	Dynamic				
1/4 (6.4)	0.25 (6.4)	0.41 (10.4)	2.75 (6.99)	5.50 (14.0)	-65 to 450 (-53 to 230)	800 (55.1)	3200 (220)	0.06 (0.09)
3/8 (9.6)	0.38 (9.6)	0.55 (14.0)	3.25 (8.26)	5.20 (13.2)		650 (44.7)	2600 (179)	0.09 (0.13)
1/2 (12.7)	0.50 (12.7)	0.70 (17.8)	5.25 (13.3)	7.88 (20.0)		450 (31.0)	1800 (124)	0.13 (0.19)
3/4 (19.0)	0.75 (19.0)	0.94 (23.9)	6.50 (16.5)	8.45 (21.5)		325 (22.3)	1300 (89.5)	0.18 (0.27)

Pressure-temperature ratings may be limited by the end connections.

Pressure-Temperature Ratings

Nominal Hose Size, in.	1/4	3/8	1/2	3/4
Temperature, °F (°C)	Working Pressure, psig (bar)			
-65 (-53)	455 (31.3)	480 (33.0)	450 (31.0)	325 (22.3)
0 (-17) to 100 (37)	800 (55.1)	650 (44.7)	450 (31.0)	325 (22.3)
200 (93)	700 (48.2)	490 (33.7)	450 (31.0)	185 (12.7)
300 (148)	330 (22.7)	490 (33.7)	315 (21.7)	175 (12.0)
400 (204)	160 (11.0)	170 (11.7)	310 (21.3)	175 (12.0)
450 (230)	160 (11.0)	170 (11.7)	295 (20.3)	160 (11.0)

F Series PTFE Hose

Testing

Every Swagelok F series hose assembly is pressure tested with water at room temperature for 30 seconds to a requirement of no detectable leakage. Testing is performed at 500 psig (34.4 bar), or 225 psig (15.5 bar) if an end connection is rated below 500 psig (34.4 bar).

Cleaning and Packaging

Every Swagelok F series hose component is cleaned in accordance with Swagelok *Standard Cleaning and Packaging (SC-10)* catalog, [MS-06-62](#).

Ordering Information

Custom Hose Assemblies

Build a hose assembly ordering number by combining the designators in the sequence shown below.



Typical Ordering Number

1 2 3 4 4 5 6 5 6 7
SS - FT 8 TA 8 KC 16 - 28 - MB or **71 CM - MB**
in. cm

1 Material

End Connections

SS = 316 stainless steel
 HC = Alloy C-276

2 Hose

FT = F series PTFE hose
 FC = F series carbon black-filled PTFE hose

3 Nominal Hose Size, in.

4 = 1/4
 6 = 3/8
 8 = 1/2
 12 = 3/4

4 End Connections

See **End Connection Designator** column in tables on pages 73 to 82.

5 Overall Length

Inches or centimeters, in whole numbers. Include **CM** as shown for centimeter lengths.

Typical maximum one-piece hose length:

- 900 in. or 2286 cm for 1/4 through 1/2 in. hose
- 600 in. or 1524 cm for 3/4 in. hose.

Longer assemblies may be spliced; specify splices under **Options**. See page 4 for more information about splices.

6 Options

For multiple options, add designators with a dash between each designator.

A = Armor guard
 C = ASTM G93 Level C cleaning on hose wetted surfaces
 F = Fire jacket
 G6 = Spiral guard, black
 G7 = Spiral guard, blue
 G8 = Spiral guard, yellow
 W = Hydrostatic test

Splices

SP1 = 1 splice
 SP2 = 2 splices

Mat Tags

MA = Gray	MO = Orange
MB = Blue	MP = Purple
MC = Brown	MR = Red
MG = Green	MW = White
MK = Black	MY = Yellow
MN = Pink	

Add 2 to the end of the Mat Tag designator for two tags.

Example: MA2

Other Tags

T = Lanyard tag
 T2 = Two lanyard tags

Specify text for tags. see **Hose Tag Text** table, page 109.

See page 107 for detailed descriptions of options.

7 Two Elbow Orientation

Only include a value in the assembly number when both end connections are elbows. See page 76 for values and further information.

U Series PFA Hose

Features

- Highly flexible PFA hose.
- Smooth-bore PFA core.
- Size range of 1/2 through 2 in. and working pressures up to 300 psig (20.6 bar).
- 302 stainless steel reinforcement ensures hose pressure containment and supports core to resist kinking.
- Silicone cover provides a smooth, noncontaminating, easy-to-clean surface and reduces internal system fluid temperature transfer.
- Hose layers are encapsulated together without adhesives or cements with a patent-pending process, providing high flexibility and outstanding kink resistance.
- PFA material complies with FDA regulation 21CFR Part 177.1550, USP <87, 88> Class VI (121°C), 3-A (for hose sizes 3/4 through 2 in.), and is free of TSE, BSE, and ADI as defined in EMEA/410/01.
- Optional carbon black-filled PFA core is available for applications that require static dissipation.
- Commonly used where high flexibility, chemical compatibility, and a smooth exterior cover are desired.
- Custom hose lengths and end connections available.
- Options include hose covers, hose tags, and additional cleaning. See page 107 for details.
- For electrical properties, see page 5 for details.

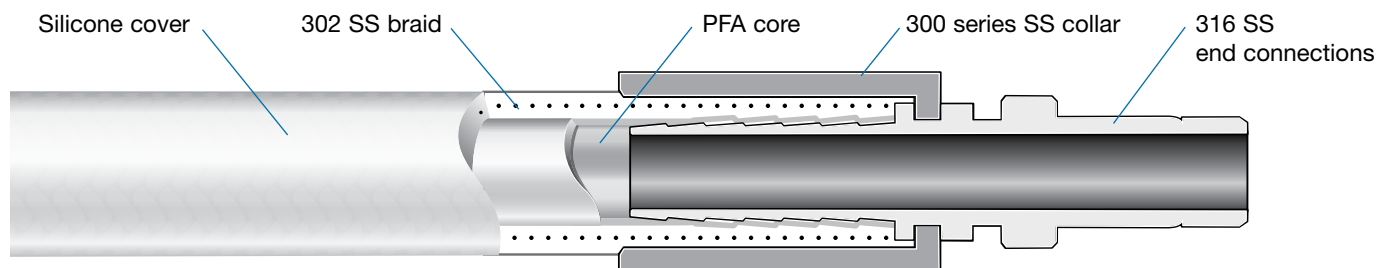

Technical Data

Nominal Hose Size in. (mm)	Inside Diameter in. (mm)	Outside Diameter in. (mm)	Minimum Inside Bend Radius in. (cm)		Temperature Range °F (°C)	Vacuum (28.5 in.Hg [96.5 kPa]) Rated to ... °F (°C)	Working Pressure at 70°F (20°C) psig (bar)	Minimum Burst Pressure at 70°F (20°C) psig (bar)	Bulk Hose Weight lb/ft (kg/m)
			Static	Dynamic					
1/2 (12.7)	0.50 (12.7)	0.81 (20.6)	1.50 (3.81)	4.50 (11.4)	-65 to 400 (-53 to 204)	400 (204)	300 (20.6)	1200 (82.6)	0.20 (0.30)
3/4 (19.0)	0.75 (19.0)	1.13 (28.7)	2.50 (6.35)	5.20 (13.2)		400 (204)	300 (20.6)	1200 (82.6)	0.38 (0.57)
1 (25.4)	1.00 (25.4)	1.48 (37.6)	4.00 (10.2)	6.50 (16.5)		250 (121)	250 (17.2)	1000 (68.9)	0.63 (0.94)
1 1/2 (38.1)	1.50 (38.1)	2.00 (50.8)	7.00 (17.8)	9.10 (23.1)		250 (121)	200 (13.7)	800 (55.1)	0.88 (1.3)
2 (50.8)	2.00 (50.8)	2.50 (63.5)	7.00 (17.8)	9.10 (23.1)		150 (65)	150 (10.3)	600 (41.3)	1.3 (1.9)

Pressure-temperature ratings may be limited by the end connections.

Pressure-Temperature Ratings

Nominal Hose Size, in.	1/2	3/4	1	1 1/2	2
Temperature, °F (°C)	Working Pressure, psig (bar)				
-65 (-53)	200 (13.7)	115 (7.9)	250 (17.2)	200 (13.7)	150 (10.3)
0 (-17) to 100 (37)	300 (20.6)	300 (20.6)	250 (17.2)	200 (13.7)	150 (10.3)
200 (93)	280 (19.2)	300 (20.6)	250 (17.2)	200 (13.7)	150 (10.3)
300 (148)	210 (14.4)	270 (18.6)	230 (15.8)	200 (13.7)	150 (10.3)
400 (204)	160 (11.0)	195 (13.4)	175 (12.0)	200 (13.7)	150 (10.3)

U Series PFA Hose

Testing

Every Swagelok U series hose assembly is pressure tested with water at room temperature for 30 seconds to a requirement of no detectable leakage. Testing is performed at 225 psig (15.5 bar).

Cleaning and Packaging

Every Swagelok U series hose component is cleaned in accordance with Swagelok *Standard Cleaning and Packaging* (SC-10) catalog, [MS-06-62](#).

Ordering Information

Custom Hose Assemblies

Build a hose assembly ordering number by combining the designators in the sequence shown below.



Typical Ordering Number

1 2 3 4 4 5 6 5 6 7
SS - UT 8 TA 8 KC 16 - 28 - PB or **71 CM - PB**
in. cm

1 Material

End Connections

SS = 316 stainless steel
 HC = Alloy C-276

2 Hose

UT = U series PFA hose with silicone cover
 UC = U series carbon black-filled PFA hose with silicone cover

3 Nominal Hose Size, in.

8 = 1/2
 12 = 3/4
 16 = 1
 24 = 1 1/2
 32 = 2

4 End Connections

See **End Connection Designator** column in tables on pages 73 to 82.

5 Overall Length

Inches or centimeters, in whole numbers. Include **CM** as shown for centimeter lengths.

Typical maximum one-piece hose length:

- 900 in. or 2286 cm for 1/2 in. hose
- 600 in. or 1524 cm for 3/4 and 1 in. hose
- 300 in. or 762 cm for 1 1/2 and 2 in. hose.

Longer assemblies may be spliced; specify splices under **Options**. See page 4 for more information about splices.

6 Options

For multiple options, add designators with a dash between each designator.

A = Armor guard
 C = ASTM G93 Level C cleaning on hose wetted surfaces
 F = Fire jacket
 G6 = Spiral guard, black
 G7 = Spiral guard, blue
 G8 = Spiral guard, yellow
 W = Hydrostatic test

Splices

SP1 = 1 splice
 SP2 = 2 splices

Mat Tags

MA = Gray	MO = Orange
MB = Blue	MP = Purple
MC = Brown	MR = Red
MG = Green	MW = White
MK = Black	MY = Yellow
MN = Pink	

Add 2 to the end of the Mat Tag designator for two tags.

Example: MA2

Perma Tags

PA = Gray	PO = Orange
PB = Blue	PP = Purple
PC = Brown	PR = Red
PG = Green	PW = White
PK = Black	PY = Yellow
PN = Pink	

Add 2 to the end of the Perma Tag designator for two tags.

Example: PA2

Other Tags

T = Lanyard tag
 T2 = Two lanyard tags

Specify text for tags. See **Hose Tag Text** table, page 109.

See page 107 for detailed descriptions of options.

7 Two Elbow Orientation

Only include a value in the assembly number when both end connections are elbows. See page 76 for values and further information.

End Connections for B, X, S, C, J, N, W, F and U Series Hose

End Connections

Swagelok Tube Adapters

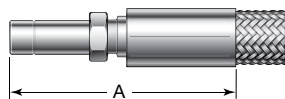

1 in. / 25 mm and Under

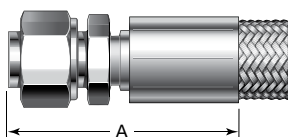

Over 1 in. / 25 mm

Tube Adapter Size	Nominal Hose Size Designator	End Connection Designator	Dimensions			Pressure Rating psig (bar)
			A Max	Minimum Inside Diameter	Maximum Outside Dimension	
Dimensions, in. (mm)						
1/8	2	TA2	1.86 (47.2)	0.070 (1.7)	0.55 (14.0)	Determined by hose
1/4	4	TA4	1.96 (49.8)	0.16 (4.0)	0.59 (15.0)	
3/8	6	TA6	2.42 (61.5)	0.26 (6.6)	0.82 (20.8)	
1/2	8	TA8	2.91 (73.9)	0.34 (8.6)	1.04 (26.4)	
3/4	12	TA12	3.53 (89.7)	0.54 (13.7)	1.35 (34.3)	
1	16	TA16	3.78 (96.0)	0.78 (19.8)	1.75 (44.5)	
1 1/2 ^①	24	TA24	5.22 (133)	1.24 (31.4)	2.60 (66.0)	
2 ^①	32	TA32	6.82 (173)	1.68 (42.6)	3.46 (87.9)	
Dimensions, mm (in.)						
3	2	TM3	47.8 (1.88)	1.7 (0.070)	14.0 (0.55)	Determined by hose
6	4	TM6	50.3 (1.98)	4.0 (0.16)	15.0 (0.59)	
10	6	TM10	62.0 (2.44)	6.6 (0.26)	20.8 (0.82)	
12	8	TM12	74.4 (2.93)	8.6 (0.34)	23.1 (0.91)	
18	12	TM18	90.2 (3.55)	13.7 (0.54)	34.3 (1.35)	
25	16	TM25	96.5 (3.80)	19.8 (0.78)	44.5 (1.75)	
38 ^①	24	TM38	133 (5.24)	31.4 (1.24)	69.3 (2.73)	
50 ^①	32	TM50	173 (6.81)	42.6 (1.68)	87.9 (3.46)	

Alloy C-276 ends available for 1 in. and under tube adapters.

① Furnished with nut and preswaged ferrules.

Swagelok Tube Fittings

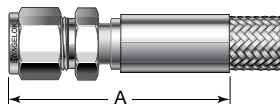

Tube Fitting Size	Nominal Hose Size Designator	End Connection Designator	Dimensions			Pressure Rating psig (bar)
			A Max	Minimum Inside Diameter	Maximum Outside Dimension	
Dimensions, in. (mm)						
1/8	2	SL2	1.88 (47.8)	0.070 (1.7)	0.55 (14.0)	Determined by hose
1/4	4	SL4	2.02 (51.3)	0.16 (4.0)	0.59 (15.0)	
3/8	6	SL6	2.48 (63.0)	0.26 (6.6)	0.82 (20.8)	
1/2	8	SL8	2.81 (71.4)	0.34 (8.6)	1.04 (26.4)	
3/4	12	SL12	3.44 (87.4)	0.54 (13.7)	1.35 (34.3)	
1	16	SL16	3.61 (91.7)	0.78 (19.8)	1.75 (44.5)	
1 1/2	24	SL24	5.12 (130)	1.24 (31.4)	2.60 (66.0)	
2	32	SL32	6.72 (171)	1.68 (42.6)	3.46 (87.9)	
Dimensions, mm (in.)						
3	2	SM3	48.5 (1.91)	1.7 (0.070)	14.0 (0.55)	Determined by hose
6	4	SM6	51.3 (2.02)	4.0 (0.16)	16.3 (0.64)	
10	6	SM10	64.5 (2.54)	6.6 (0.26)	20.8 (0.82)	
12	8	SM12	71.9 (2.83)	8.6 (0.34)	26.4 (1.04)	
18	12	SM18	78.0 (3.07)	13.7 (0.54)	34.3 (1.35)	
25	16	SM25	91.7 (3.61)	19.8 (0.78)	44.5 (1.75)	
38	24	SM38	133 (5.24)	31.4 (1.24)	69.3 (2.73)	
50	32	SM50	169 (6.65)	42.6 (1.68)	87.9 (3.46)	

Alloy C-276 ends available for 1 in. and under tube fittings.

End Connections for B, X, S, C, J, N, W, F and U Series Hose

Female Pipe Threads, NPT

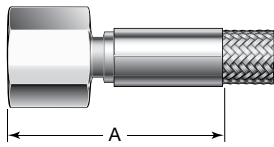

NPT Size in.	Nominal Hose Size Designator	End Connection Designator	Dimensions, in. (mm)			Pressure Rating psig (bar)
			A Max	Minimum Inside Diameter	Maximum Outside Dimension	
1/8	2	PF2	1.76 (44.7)	0.070 (1.7)	0.65 (16.5)	Determined by hose ^①
1/4	4	PF4	1.85 (47.0)	0.16 (4.0)	0.87 (22.1)	
3/8	6	PF6	2.31 (58.7)	0.26 (6.6)	1.01 (25.7)	
1/2	8	PF8	2.66 (67.6)	0.34 (8.6)	1.30 (33.0)	
3/4	12	PF12	3.32 (84.3)	0.54 (13.7)	1.52 (38.6)	
1	16	PF16	3.44 (87.4)	0.78 (19.8)	1.88 (47.8)	
1 1/2	24	PF24	4.19 (106)	1.24 (31.4)	2.75 (69.9)	
2	32	PF32	4.88 (124)	1.68 (42.6)	3.18 (80.8)	

① Brass PF4 pressure rating is 3300 psig (228 bar).

Female Pipe Threads, NPT, with JIC (AN) 37° Union

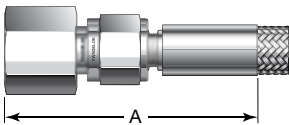

NPT with JIC Union Size in.	Nominal Hose Size Designator	End Connection Designator	Dimensions, in. (mm)			Pressure Rating psig (bar)
			A Max	Minimum Inside Diameter	Maximum Outside Dimension	
1/8	2	FU2	2.38 (60.5)	0.070 (1.7)	0.65 (16.5)	Determined by hose
1/4	4	FU4	2.61 (66.3)	0.16 (4.0)	0.87 (22.1)	
3/8	6	FU6	3.07 (78.0)	0.26 (6.6)	1.01 (25.7)	
1/2	8	FU8	3.59 (91.2)	0.34 (8.6)	1.23 (31.2)	
3/4	12	FU12	4.47 (114)	0.54 (13.7)	1.52 (38.6)	
1	16	FU16	4.77 (121)	0.78 (19.8)	2.02 (51.3)	
1 1/2	24	FU24	6.12 (155)	1.24 (31.4)	2.75 (69.9)	
2	32	FU32	7.05 (179)	1.68 (42.6)	3.46 (87.9)	

Male Pipe Threads, NPT

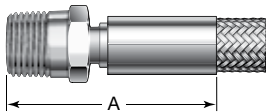

NPT Size in.	Nominal Hose Size Designator	End Connection Designator	Dimensions, in. (mm)			Pressure Rating psig (bar)
			A Max	Minimum Inside Diameter	Maximum Outside Dimension	
1/8	2	PM2	1.70 (43.2)	0.077 (1.9)	0.55 (14.0)	Determined by hose
1/4	4	PM4	1.91 (48.5)	0.16 (4.0)	0.65 (16.5)	
3/8	6	PM6	2.31 (58.7)	0.28 (7.1)	0.82 (20.8)	
1/2	8	PM8	2.72 (69.1)	0.37 (9.4)	1.04 (26.4)	
3/4	12	PM12	3.26 (82.8)	0.63 (16.0)	1.35 (34.3)	
1	16	PM16	3.45 (87.6)	0.78 (19.8)	1.75 (44.5)	
1 1/2	24	PM24	4.24 (108)	1.36 (34.5)	2.31 (58.7)	
2	32	PM32	5.12 (130)	1.84 (46.7)	2.89 (73.4)	

Male Pipe Threads, NPT, with JIC (AN) 37° Union

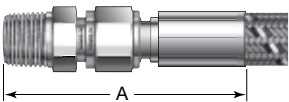

NPT with JIC Union Size in.	Nominal Hose Size Designator	End Connection Designator	Dimensions, in. (mm)			Pressure Rating psig (bar)
			A Max	Minimum Inside Diameter	Maximum Outside Dimension	
1/8	2	MU2	2.37 (60.2)	0.070 (1.7)	0.55 (14.0)	Determined by hose
1/4	4	MU4	2.70 (68.6)	0.16 (4.0)	0.65 (16.5)	
3/8	6	MU6	3.19 (81.0)	0.26 (6.6)	0.82 (20.8)	
1/2	8	MU8	3.71 (94.2)	0.34 (8.6)	1.04 (26.4)	
3/4	12	MU12	4.52 (115)	0.54 (13.7)	1.45 (36.8)	
1	16	MU16	4.75 (121)	0.78 (19.8)	1.75 (44.5)	
1 1/2	24	MU24	5.88 (149)	1.24 (31.4)	2.60 (66.0)	
2	32	MU32	7.08 (180)	1.68 (42.6)	3.32 (84.3)	

End Connections for B, X, S, C, J, N, W, F and U Series Hose

Sanitary Kwik-Clamps^①

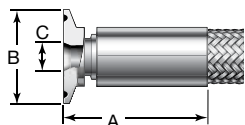

① 316L SS material with an I.D. of 15 µin. (0.38 µm) R_a max surface finish applies prior to crimp.

Kwik-Clamp Size in.	Nominal Hose Size Designator	End Connection Designator		Dimensions, in. (mm)				Pressure Rating psig (bar)
		Standard Surface	Electro-polished	A Max	Minimum Inside Diameter	B, Flange Outside Diameter	C, Flange Face Inside Diameter	
1/2	4	KC8	KE8	1.60 (40.6)	0.16 (4.0)	0.98 (25.0)	0.37 (9.4)	1500 (103)
	6	KC8	KE8	2.23 (56.6)	0.26 (6.6)			
	8	KC8	KE8	2.61 (66.3)	0.34 (8.6)			
3/4	6	KC12	KE12	2.23 (56.6)	0.26 (6.6)	0.98 (25.0)	0.62 (15.7)	1500 (103)
	8	KC12	KE12	2.48 (63.0)	0.34 (8.6)			
	12	KC12	KE12	2.85 (72.4)	0.54 (13.7)			
1	8	KC16	KE16	2.44 (62.0)	0.34 (8.6)	1.98 (50.3)	0.87 (22.1)	500 (34.4)
	12	KC16	KE16	2.70 (68.6)	0.54 (13.7)			
	16	KC16	KE16	2.76 (70.1)	0.78 (19.8)			
1 1/2	8	KC24	KE24	2.45 (62.2)	0.34 (8.6)	1.98 (50.3)	1.37 (34.8)	500 (34.4)
	12	KC24	KE24	2.70 (68.6)	0.54 (13.7)			
	16	KC24	KE24	2.60 (66.0)	0.78 (19.8)			
	24	KC24	KE24	3.31 (84.1)	1.24 (31.4)			
2	16	KC32	KE32	2.60 (66.0)	0.78 (19.8)	2.52 (64.0)	1.87 (47.5)	450 (31.0)
	24	KC32	KE32	3.21 (81.5)	1.24 (31.4)			
	32	KC32	KE32	3.98 (101)	1.68 (42.6)			
2 1/2	24	KC40	KE40	3.32 (84.3)	1.24 (31.4)	3.05 (77.5)	2.37 (60.2)	400 (27.5)
	32	KC40	KE40	3.97 (101)	1.68 (42.6)			

Sanitary Kwik-Clamp 90° Elbows

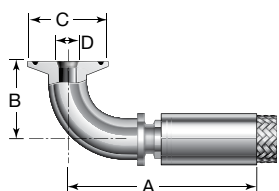

Kwik-Clamp Size in.	Nominal Hose Size Designator	End Connection Designator		Dimensions, in. (mm)					Pressure Rating psig (bar)
		Standard Surface	Electro-polished	A Max	B	Minimum Inside Diameter	C, Flange Outside Diameter	D, Flange Face Inside Diameter	
1/2	8	KR8	RE8	2.92 (74.2)	1.27 (32.3)	0.34 (8.6)	0.98 (25.0)	0.37 (9.4)	1500 (103)
3/4	12	KR12	RE12	3.45 (87.6)	1.63 (41.4)	0.54 (13.7)	0.98 (25.0)	0.62 (15.7)	1500 (103)
1	16	KR16	RE16	4.10 (104)	2.02 (51.3)	0.78 (19.8)	1.98 (50.3)	0.87 (22.1)	500 (34.4)
1 1/2	24	KR24	RE24	5.90 (150)	2.77 (70.4)	1.24 (31.4)	1.98 (50.3)	1.37 (34.8)	500 (34.4)
2	32	KR32	RE32	7.56 (192)	3.51 (89.2)	1.68 (42.6)	2.52 (64.0)	1.87 (47.5)	450 (31.0)

End Connections for B, X, S, C, J, N, W, F and U Series Hose

Sanitary Kwik-Clamp 45° Elbows

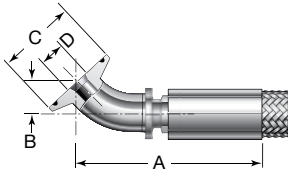

Kwik-Clamp Size in.	Nominal Hose Size Designator	End Connection Designator		Dimensions, in. (mm)					Pressure Rating psig (bar)
		Standard Surface	Electro-polished	A Max	B	Minimum Inside Diameter	C, Flange Outside Diameter	D, Flange Face Inside Diameter	
1/2	8	KA8	AE8	3.05 (77.5)	0.70 (17.8)	0.34 (8.6)	0.98 (25.0)	0.37 (9.4)	1500 (103)
3/4	12	KA12	AE12	3.85 (97.8)	0.69 (17.6)	0.54 (13.7)	0.98 (25.0)	0.62 (15.7)	1500 (103)
1	16	KA16	AE16	4.02 (102)	0.81 (20.5)	0.78 (19.8)	1.98 (50.3)	0.87 (22.1)	500 (34.4)
1 1/2	24	KA24	AE24	5.60 (142)	1.03 (26.2)	1.24 (31.4)	1.98 (50.3)	1.37 (34.8)	500 (34.4)
2	32	KA32	AE32	7.03 (179)	1.27 (32.3)	1.68 (42.6)	2.52 (64.0)	1.87 (47.5)	450 (31.0)

Two Elbow Hose Options

For hoses with two elbow end connections, a suffix is needed to indicate the angle offset between the first end connection and the second end connection. The first end connection is indicated by the first end connection designator in the part number. The second end connection is indicated by the second end connection designator in the part number. See the table and diagram below for the part number suffix and its corresponding angle offset.

Part Number Suffix	Rotation Amount
-0	0°
-1	45°
-2	90°
-3	135°
-4	180°
-5	225°
-6	270°
-7	315°

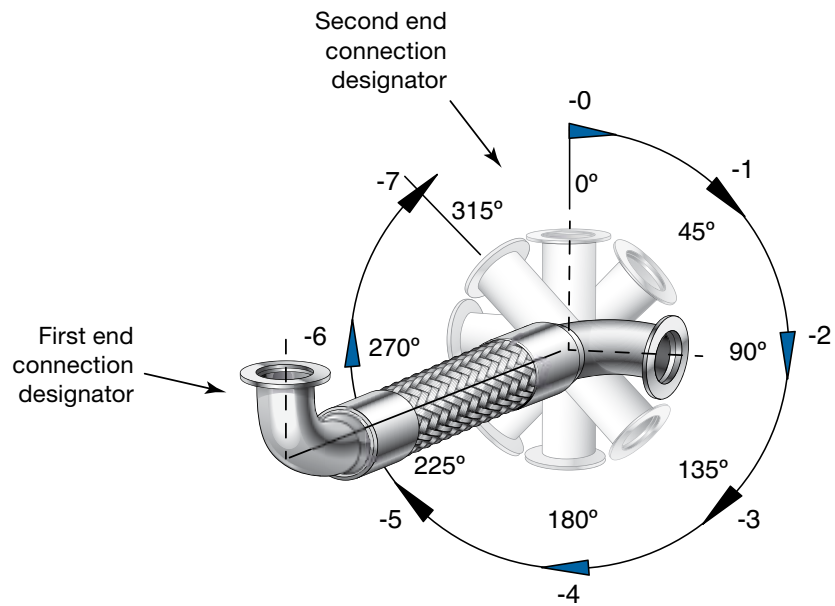

End Connections for B, X, S, C, J, N, W, F and U Series Hose

Tube Butt Welds^①

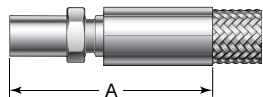

① 316 SS material with an I.D. of 15 µin. (0.38 µm) R_a max surface finish applies prior to crimp.

Tube Butt Weld Size in.	Wall Thickness in.	Nominal Hose Size Designator	End Connection Designator	Dimensions, in. (mm)			Pressure Rating psig (bar)
				A Max	Minimum Inside Diameter	Maximum Outside Dimension	
1/2	0.049	8	TB8	2.70 (68.6)	0.34 (8.6)	1.04 (26.4)	Determined by hose
3/4	0.049	12	TB12	3.26 (82.8)	0.54 (13.7)	1.35 (34.3)	
1	0.065	16	TB16	3.26 (82.8)	0.78 (19.8)	1.75 (44.5)	
1 1/2	0.095	24	TB24	4.65 (118)	1.24 (31.4)	2.20 (55.9)	
2	0.109	32	TB32	5.56 (141)	1.68 (42.6)	2.75 (69.9)	

SAE 37° (JIC) Female Swivel

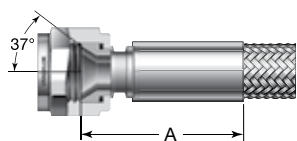

SAE 37° (JIC) Female Swivel Size in.	Nominal Hose Size Designator	End Connection Designator	Dimensions, in. (mm)			Pressure Rating psig (bar)
			A Max	Minimum Inside Diameter	Maximum Outside Dimension	
1/8	2	AS2	1.05 (26.7)	0.070 (1.7)	0.55 (14.0)	Determined by hose
1/4	4	AS4	1.41 (35.8)	0.16 (4.0)	0.66 (16.8)	
3/8	6	AS6	2.05 (52.1)	0.26 (6.6)	0.82 (20.8)	
1/2	8	AS8	2.26 (57.4)	0.34 (8.6)	1.04 (26.4)	
3/4	12	AS12	2.63 (66.8)	0.54 (13.7)	1.35 (34.3)	
1	16	AS16	2.62 (66.5)	0.78 (19.8)	1.75 (44.5)	
1 1/2	24	AS24	3.30 (83.8)	1.24 (31.4)	2.61 (66.3)	
2	32	AS32	4.84 (123)	1.68 (42.6)	3.33 (84.6)	

Female Cam and Groove

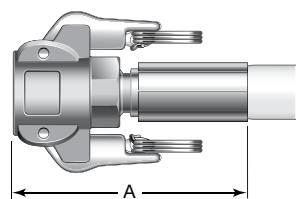

Female Cam and Groove Size in.	Nominal Hose Size Designator	End Connection Designator	Dimensions, in. (mm)			Pressure Rating psig (bar)
			A Max	Minimum Inside Diameter	Maximum Outside Dimension	
3/4	12	GF12	4.03 (102)	0.54 (13.7)	3.27 (83.1)	250 (17.2)
1	16	GF16	4.53 (115)	0.78 (19.8)	3.50 (88.9)	
1 1/2	24	GF24	5.39 (137)	1.24 (31.4)	4.44 (113)	
2	32	GF32	6.30 (160)	1.68 (42.6)	4.82 (122)	

The A dimension may vary if armor guard hose cover is ordered.

Male Cam and Groove

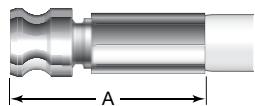

Male Cam and Groove Size in.	Nominal Hose Size Designator	End Connection Designator	Dimensions, in. (mm)			Pressure Rating psig (bar)
			A Max	Minimum Inside Diameter	Maximum Outside Dimension	
3/4	12	GM12	2.92 (74.2)	0.54 (13.7)	1.27 (32.3)	250 (17.2)
1	16	GM16	3.54 (89.9)	0.78 (19.8)	1.45 (36.8)	
1 1/2	24	GM24	4.40 (112)	1.24 (31.4)	2.11 (53.6)	
2	32	GM32	5.15 (131)	1.68 (42.6)	2.47 (62.7)	

End Connections for B, X, S, C, J, N, W, F and U Series Hose

Tube Stubs, Annealed

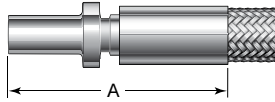

Tube Stub Size	Wall Thickness	Nominal Hose Size Designator	End Connection Designator	Dimensions			Pressure Rating psig (bar)
				A Max	Minimum Inside Diameter	Maximum Outside Dimension	
Dimensions, in. (mm)							
1/8	0.028	2	TN2	1.96 (49.8)	0.069 (1.8)	0.31 (7.9)	Determined by hose
1/4	0.035	4	TN4	2.24 (56.9)	0.16 (4.1)	0.46 (11.7)	
3/8	0.049	6	TN6	2.55 (64.8)	0.26 (6.6)	0.63 (16.0)	
1/2	0.049	8	TN8	3.08 (78.2)	0.34 (8.6)	0.86 (21.8)	
3/4	0.065	12	TN12	3.45 (87.6)	0.54 (13.7)	0.99 (25.1)	
1	0.083	16	TN16	3.92 (99.6)	0.78 (19.8)	1.39 (35.3)	
1 1/2	0.134	24	TN24	6.08 (154)	1.24 (31.5)	1.96 (49.8)	
2	0.188	32	TN32	6.74 (171)	1.68 (42.7)	2.43 (61.7)	
Dimensions, mm (in.)							
3	0.80	2	TE3	41.7 (1.64)	1.3 (0.052)	7.9 (0.31)	Determined by hose
6	1.0	4	TE6	57.2 (2.25)	4.0 (0.16)	11.7 (0.46)	
8	1.0	4	TE8	57.9 (2.28)	4.0 (0.16)	16.0 (0.63)	
8	1.0	6	TE8	64.3 (2.53)	6.0 (0.24)	16.0 (0.63)	
10	1.0	6	TE10	65.0 (2.56)	6.6 (0.26)	16.0 (0.63)	
12	1.0	6	TE12	71.6 (2.82)	6.6 (0.26)	16.0 (0.63)	
12	1.0	8	TE12	77.5 (3.05)	8.7 (0.34)	21.9 (0.86)	
18	1.5	12	TE18	87.4 (3.44)	13.8 (0.54)	25.1 (0.99)	
25	1.5	16	TE25	101 (3.98)	19.7 (0.78)	35.4 (1.39)	
38	3.5	24	TE38	133 (5.23)	30.9 (1.22)	50.5 (1.99)	
50	5.0	32	TE50	179 (7.03)	39.9 (1.57)	64.8 (2.55)	

Female VCO O-Ring Face Seal Fittings

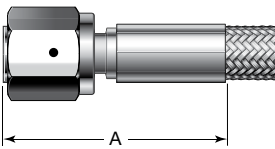

VCO Size in.	Nominal Hose Size Designator	End Connection Designator	Dimensions, in. (mm)			Pressure Rating psig (bar)
			A Max	Minimum Inside Diameter	Maximum Outside Dimension	
1/4	4	VF4	1.67 (42.4)	0.16 (4.0)	0.80 (20.3)	Determined by hose
1/2	8	VF8	2.18 (55.4)	0.34 (8.6)	1.16 (29.5)	
3/4	12	VF12	2.79 (70.9)	0.54 (13.7)	1.74 (44.2)	
1	16	VF16	2.67 (67.8)	0.78 (19.8)	2.03 (51.6)	

Female VCR Metal Gasket Face Seal Fittings

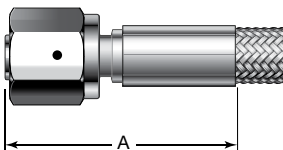

VCR Size in.	Nominal Hose Size Designator	End Connection Designator	Dimensions, in. (mm)			Pressure Rating psig (bar)
			A Max	Minimum Inside Diameter	Maximum Outside Dimension	
1/4	4	RF4	1.76 (44.7)	0.16 (4.0)	0.87 (22.1)	Determined by hose
1/2	8	RF8	2.37 (60.2)	0.34 (8.6)	1.23 (31.2)	
3/4	12	RF12	3.08 (78.2)	0.54 (13.7)	1.74 (44.2)	
1	16	RF16	3.20 (81.3)	0.78 (19.8)	2.03 (51.6)	

End Connections for B, X, S, C, J, N, W, F and U Series Hose

TS Series Sanitary Clamps^①

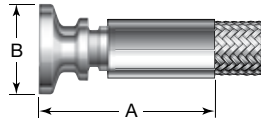

① 316L SS material with an I.D. of 15 µin. (0.38 µm) R_a max surface finish applies prior to crimp.

Sanitary Clamp Size in.	Nominal Hose Size Designator	End Connection Designator	Dimensions, in. (mm)			Maximum Outside Dimension	Pressure Rating psig (bar)
			A Max	Minimum Inside Diameter	B, Flange Outside Diameter		
1/2	8	TS8	2.20 (55.9)	0.34 (8.6)	0.98 (25.0)	1.04 (26.4)	3100 (213)
3/4	12	TS12	2.70 (68.6)	0.54 (13.7)	0.98 (25.0)	1.35 (34.3)	2800 (192)
1	16	TS16	2.88 (73.2)	0.78 (19.8)	1.98 (50.3)	1.98 (50.3)	1200 (82.6)
1 1/2	24	TS24	3.35 (85.1)	1.24 (31.4)	1.98 (50.3)	2.20 (55.9)	1200 (82.6)
2	32	TS32	4.01 (102)	1.68 (42.6)	2.52 (64.0)	2.74 (69.6)	650 (44.7)

Male Pipe Threads, ISO/BSP Tapered (ISO 7)

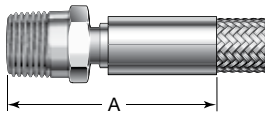

Male Pipe Thread, ISO/BSP Tapered Size in.	Nominal Hose Size Designator	End Connection Designator	Dimensions, in. (mm)			Pressure Rating psig (bar)
			A Max	Minimum Inside Diameter	Maximum Outside Dimension	
1/4	4	MT4	1.91 (48.5)	0.16 (4.0)	0.66 (16.8)	Determined by hose
3/8	6	MT6	2.31 (58.7)	0.26 (6.6)	0.82 (20.8)	
1/2	8	MT8	2.72 (69.1)	0.34 (8.6)	1.04 (26.4)	
3/4	12	MT12	3.26 (82.8)	0.54 (13.7)	1.35 (34.3)	
1	16	MT16	3.45 (87.6)	0.78 (19.8)	1.75 (44.5)	
1 1/2	24	MT24	4.25 (108)	1.24 (31.4)	2.31 (58.7)	
2	32	MT32	5.12 (130)	1.68 (42.6)	2.89 (73.4)	

Male ISO/BSP Parallel Threads with 60° Male Cone (ISO 228)

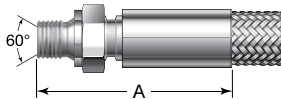

ISO/BSP Parallel, 60° Male Cone Size in.	Nominal Hose Size Designator	End Connection Designator	Dimensions, in. (mm)			Pressure Rating psig (bar)
			A Max	Minimum Inside Diameter	Maximum Outside Dimension	
1/4	4	MS4	1.99 (50.5)	0.16 (4.0)	0.87 (22.1)	Determined by hose
3/8	6	MS6	2.38 (60.5)	0.26 (6.6)	1.01 (25.7)	
1/2	8	MS8	2.65 (67.3)	0.34 (8.6)	1.23 (31.2)	
3/4	12	MS12	3.37 (85.6)	0.54 (13.7)	1.52 (38.6)	
1	16	MS16	3.38 (85.9)	0.78 (19.8)	1.88 (47.8)	
1 1/2	24	MS24	4.21 (107)	1.24 (31.4)	2.53 (64.3)	
2	32	MS32	5.16 (131)	1.68 (42.6)	3.18 (80.8)	

Female Pipe Threads, ISO/BSP Tapered (ISO 7)

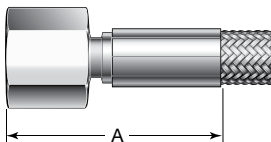

Female Pipe Thread, ISO/BSP Tapered Size in.	Nominal Hose Size Designator	End Connection Designator	Dimensions, in. (mm)			Pressure Rating psig (bar)
			A Max	Minimum Inside Diameter	Maximum Outside Dimension	
1/4	4	FT4	1.85 (47.0)	0.16 (4.0)	0.87 (22.1)	Determined by hose
3/8	6	FT6	2.32 (58.9)	0.26 (6.6)	1.01 (25.7)	
1/2	8	FT8	2.67 (67.8)	0.34 (8.6)	1.23 (31.2)	
3/4	12	FT12	3.37 (85.6)	0.54 (13.7)	1.52 (38.6)	
1	16	FT16	3.45 (87.6)	0.78 (19.8)	1.88 (47.8)	
1 1/2	24	FT24	4.15 (105)	1.24 (31.4)	2.75 (69.9)	
2	32	FT32	4.99 (127)	1.68 (42.6)	3.32 (84.3)	

End Connections for B, X, S, C, J, N, W, F and U Series Hose

Female ISO/BSP Parallel Threads (ISO 228)

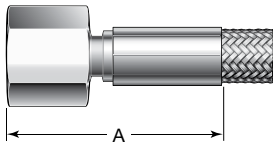

ISO/BSP Parallel Thread Size in.	Nominal Hose Size Designator	End Connection Designator	Dimensions, in. (mm)			Pressure Rating psig (bar)
			A Max	Minimum Inside Diameter	Maximum Outside Dimension	
1/4	4	FS4	2.06 (52.3)	0.16 (4.0)	0.87 (22.1)	Determined by hose
3/8	6	FS6	2.57 (65.3)	0.26 (6.6)	1.09 (27.7)	
1/2	8	FS8	2.84 (72.1)	0.34 (8.6)	1.23 (31.2)	
3/4	12	FS12	3.39 (86.1)	0.54 (13.7)	1.59 (40.4)	
1	16	FS16	3.46 (87.9)	0.78 (19.8)	1.88 (47.8)	
1 1/2	24	FS24	4.29 (109)	1.24 (31.4)	2.60 (66.0)	
2	32	FS32	4.95 (126)	1.68 (42.6)	3.18 (80.8)	

Female Swivel ISO/BSP Parallel Threads with 30° Cone

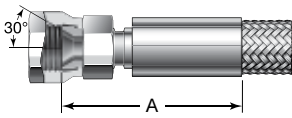

Swivel ISO/BSP Parallel Thread, 30° Cone Size in.	Nominal Hose Size Designator	End Connection Designator	Dimensions, in. (mm)			Pressure Rating psig (bar)
			A Max	Minimum Inside Diameter	Maximum Outside Dimension	
1/4	4	BS4	1.94 (49.3)	0.16 (4.0)	0.87 (22.1)	Determined by hose
3/8	6	BS6	2.59 (65.8)	0.26 (6.6)	1.01 (25.7)	
1/2	8	BS8	2.81 (71.4)	0.34 (8.6)	1.23 (31.2)	

Female Swivel ISO/BSP Parallel Threads with 60° Cone

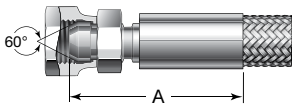

Swivel ISO/BSP Parallel Thread, 60° Cone Size in.	Nominal Hose Size Designator	End Connection Designator	Dimensions, in. (mm)			Pressure Rating psig (bar)
			A Max	Minimum Inside Diameter	Maximum Outside Dimension	
1/4	4	BM4	1.94 (49.3)	0.16 (4.0)	0.87 (22.1)	Determined by hose
3/8	6	BM6	2.59 (65.8)	0.26 (6.6)	1.01 (25.7)	
1/2	8	BM8	2.81 (71.4)	0.34 (8.6)	1.23 (31.2)	

JIS(A)/ISO 2852-Type Sanitary^①

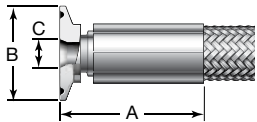

JIS(A)/ISO 2852-Type Sanitary Size	Nominal Hose Size Designator	End Connection Designator		Dimensions, in. (mm)			Pressure Rating psig (bar)
		Standard Surface	Electro-polished	A Max	Minimum Inside Diameter	B, Flange Outside Diameter	
8A	6	JS8	JE8	2.16 (54.9)	0.26 (6.6)	1.34 (34.0)	500 (34.4)
10A	8	JS10	JE10	2.34 (59.4)	0.34 (8.6)		
15A	12	JS15	JE15	2.88 (73.2)	0.54 (13.7)		

① 316L SS material with an I.D. of 15 μin. (0.38 μm) R_a max surface finish applies prior to crimp.

ISO-KF Vacuum Flange

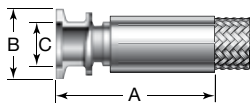

ISO-KF Vacuum Flange Size mm	Nominal Hose Size Designator	End Connection Designator	Dimensions, mm (in.)				Pressure Rating bar (psig)
			A Max	Minimum Inside Diameter	B, Flange Outside Diameter	C, Flange Face Inside Diameter	
16	12	KF16	71.1 (2.80)	13.7 (0.54)	30.0 (1.18)	34.3 (1.35)	10.0 (145)
25	16	KF25	68.6 (2.70)	19.8 (0.78)	40.0 (1.57)	44.5 (1.75)	
40	24	KF40	82.6 (3.25)	31.4 (1.24)	55.0 (2.16)	55.9 (2.20)	
50	32	KF50	106 (4.16)	42.6 (1.68)	75.0 (2.95)	75.2 (2.96)	
						52.6 (2.07)	

End Connections for B, X, S, C, J, N, W, F and U Series Hose

Sanitary DIN 11864-3 Series A, Form A, Clamp Ferrule with Groove^①

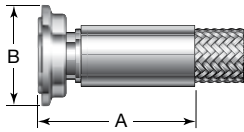

① 316L SS material with an I.D. of 15 μm . (0.38 μm) R_a max surface finish applies prior to crimp.

Sanitary DIN 11864-3 Series A, Form A, Clamp Ferrule with Groove, Size mm	Nominal Hose Size Designator	End Connection Designator	Dimensions, mm (in.)			Pressure Rating bar (psig)
			A Max	Minimum Inside Diameter	B, Flange Outside Diameter	
10	6	DB10	51.8 (2.04)	6.6 (0.26)	35.6 (1.40)	40.0 (580)
15	8	DB15	56.9 (2.24)	8.6 (0.34)	34.0 (1.34)	
	12	DB15	70.4 (2.77)	13.7 (0.54)	34.0 (1.34)	
20	12	DB20	60.5 (2.38)	13.7 (0.54)	50.3 (1.98)	
25	16	DB25	67.3 (2.65)	19.8 (0.78)	50.3 (1.98)	
40	24	DB40	83.6 (3.29)	31.4 (1.24)	64.0 (2.52)	
50	32	DB50	101 (3.97)	42.6 (1.68)	77.5 (3.05)	

Female DIN 11851 with Nut^①

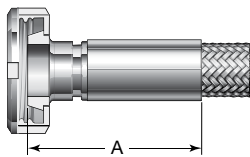

① 316L SS material with an I.D. of 15 μm . (0.38 μm) R_a max surface finish applies prior to crimp.

Female DIN 11851 with Nut Size mm	Nominal Hose Size Designator	End Connection Designator	Dimensions, mm (in.)			Pressure Rating bar (psig)
			A Max	Minimum Inside Diameter	Maximum Outside Dimension	
15	8	DF15	57.4 (2.26)	8.6 (0.34)	44.2 (1.74)	40.0 (580)
20	12	DF20	73.7 (2.90)	13.7 (0.54)	54.4 (2.14)	
25	16	DF25	70.6 (2.78)	19.8 (0.78)	63.2 (2.49)	
40	24	DF40	87.6 (3.45)	31.4 (1.24)	78.2 (3.08)	24.8 (360)
50	32	DF50	106 (4.19)	42.6 (1.68)	92.2 (3.63)	

ASME Class 150 Lap Joint Flange

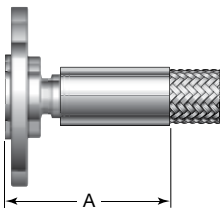

ASME Class 150 Lap Joint Flange Size in.	Nominal Hose Size Designator	End Connection Designator	Dimensions, in. (mm)			Pressure Rating psig (bar)
			A Max	Minimum Inside Diameter	Maximum Outside Dimension	
1/2	8	GA8	2.75 (69.9)	0.34 (8.6)	3.56 (90.4)	275 (18.9)
3/4	12	GA12	3.41 (86.6)	0.54 (13.7)	3.91 (99.3)	
1	16	GA16	3.38 (85.9)	0.78 (19.8)	4.28 (109)	
1 1/2	24	GA24	4.09 (104)	1.24 (31.4)	5.03 (128)	
2	32	GA32	5.06 (129)	1.68 (42.6)	6.03 (153)	

JIS 10K Lap Joint Flange

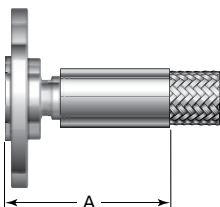

JIS 10K Lap Joint Flange Size mm	Nominal Hose Size Designator	End Connection Designator	Dimensions, mm (in.)			Pressure Rating bar (psig)
			A Max	Minimum Inside Diameter	Maximum Outside Dimension	
15	8	HA15	69.9 (2.75)	8.6 (0.34)	95.3 (3.75)	9.7 (142)
20	12	HA20	86.6 (3.41)	13.7 (0.54)	100 (3.95)	
25	16	HA25	85.9 (3.38)	19.8 (0.78)	125 (4.93)	
40	24	HA40	104 (4.09)	31.4 (1.24)	140 (5.52)	
50	32	HA50	123 (4.86)	42.6 (1.68)	155 (6.11)	

DIN PN10 Lap Joint Flange

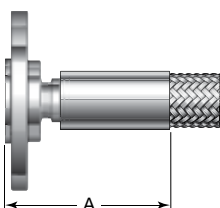

DIN PN10 Lap Joint Flange Size mm	Nominal Hose Size Designator	End Connection Designator	Dimensions, mm (in.)			Pressure Rating bar (psig)
			A Max	Minimum Inside Diameter	Maximum Outside Dimension	
15	8	FA15	69.9 (2.75)	8.6 (0.34)	95.3 (3.75)	10.0 (145)
20	12	FA20	86.6 (3.41)	13.7 (0.54)	105 (4.14)	
25	16	FA25	88.9 (3.50)	19.8 (0.78)	115 (4.54)	
40	24	FA40	121 (4.76)	31.4 (1.24)	150 (5.92)	
50	32	FA50	123 (4.86)	42.6 (1.68)	165 (6.51)	

End Connections for B, X, S, C, J, N, W, F and U Series Hose

Sanitary I-Line Male^①

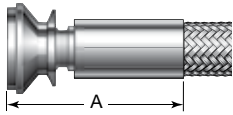

① 316L SS material with an I.D. of 15 µin. (0.38 µm) R_a max surface finish applies prior to crimp.

Sanitary I-Line Male Size in.	Nominal Hose Size Designator	End Connection Designator	Dimensions, in. (mm)			Pressure Rating psig (bar)
			A Max	Minimum Inside Diameter	Maximum Outside Dimension	
1	16	MD16	2.99 (75.9)	0.78 (19.8)	2.01 (51.1)	1220 (84.0)
1 1/2	24	MD24	3.70 (94.0)	1.24 (31.4)	2.20 (55.9)	1220 (84.0)
2	32	MD32	4.45 (113)	1.68 (42.6)	2.74 (69.6)	900 (62.0)

Sanitary I-Line Female^①

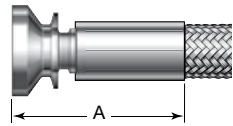

① 316L SS material with an I.D. of 15 µin. (0.38 µm) R_a max surface finish applies prior to crimp.

Sanitary I-Line Female Size in.	Nominal Hose Size Designator	End Connection Designator	Dimensions, in. (mm)			Pressure Rating psig (bar)
			A Max	Minimum Inside Diameter	Maximum Outside Dimension	
1	16	FD16	2.98 (75.7)	0.78 (19.8)	2.01 (51.1)	1220 (84.0)
1 1/2	24	FD24	3.69 (93.7)	1.24 (31.4)	2.20 (55.9)	1220 (84.0)
2	32	FD32	4.44 (113)	1.68 (42.6)	2.74 (69.6)	900 (62.0)

Sanitary (DIN 32676)^①

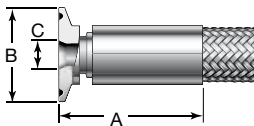

① 316L SS material with an I.D. of 15 µin. (0.38 µm) R_a max surface finish applies prior to crimp.

Sanitary (DIN 32676) Size mm	Nominal Hose Size Designator	End Connection Designator	Dimensions, mm (in.)				Pressure Rating bar (psig)
			A Max	Minimum Inside Diameter	B, Flange Outside Diameter	C, Flange Face Inside Diameter	
10	4	DA10	46.0 (1.81)	4.0 (0.16)	34.0 (1.34)	10.2 (0.40)	15.8 (230)
	6	DA10	56.1 (2.21)	6.6 (0.26)	34.0 (1.34)		
	8	DA10	56.6 (2.23)	8.6 (0.34)	34.0 (1.34)		
15	8	DA15	58.9 (2.32)	8.6 (0.34)	34.0 (1.34)	16.1 (0.63)	
	12	DA15	72.6 (2.86)	13.7 (0.54)	34.0 (1.34)		
20	12	DA20	72.6 (2.86)	13.7 (0.54)	34.0 (1.34)	20.1 (0.79)	
25	16	DA25	72.6 (2.86)	19.8 (0.78)	50.5 (1.99)	26.1 (1.03)	
32	16	DA32	72.6 (2.86)	19.8 (0.78)	50.5 (1.99)	32.1 (1.26)	
40	24	DA40	84.6 (3.33)	31.4 (1.24)	50.5 (1.99)	38.1 (1.50)	
50	32	DA50	113 (4.44)	42.6 (1.68)	64.0 (2.52)	50.1 (1.97)	

Sanitary (ISO 2852)^①

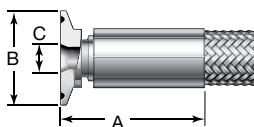

① 316L SS material with an I.D. of 15 µin. (0.38 µm) R_a max surface finish applies prior to crimp.

Sanitary (ISO 2852) Size mm	Nominal Hose Size Designator	End Connection Designator	Dimensions, mm (in.)				Pressure Rating bar (psig)
			A Max	Minimum Inside Diameter	B, Flange Outside Diameter	C, Flange Face Inside Diameter	
12	8	ES12	58.4 (2.30)	8.6 (0.34)	34.0 (1.34)	9.9 (0.39)	103 (1500)
13	6	ES13	54.1 (2.13)	6.6 (0.26)	34.0 (1.34)	10.3 (0.41)	
20	12	ES20	72.6 (2.86)	13.7 (0.54)	34.0 (1.34)	19.3 (0.76)	
26	12	ES26	73.9 (2.91)	13.7 (0.54)	50.5 (1.99)	23.7 (0.93)	
25	16	ES25	72.4 (2.85)	19.8 (0.78)	50.5 (1.99)	22.6 (0.89)	34.4 (500)
40	24	ES40	88.9 (3.50)	31.4 (1.24)	64.0 (2.52)	37.6 (1.48)	34.4 (500)
50	32	ES50	106 (4.16)	42.6 (1.68)	64.0 (2.52)	48.5 (1.91)	31.0 (450)

PFA Series PFA Tubing

Features

- Chemically resistant, translucent PFA flexible tubing.
- Smooth-bore, perfluoroalkoxy (PFA) material.
- Size range of 1/8 through 1 in. and 6 through 12 mm and working pressures up to 275 psig (18.9 bar).
- PFA tubing material in accordance with ASTM D3307, Type II.
- Flexible tubing commonly used where chemical compatibility is desired.
- Designed for use with both Swagelok PFA tube fittings and metal Swagelok tube fittings.
- Groove cutter required for installation of Swagelok PFA tube fittings. See page 84.
- Tube cutter tool is available. See page 114 for details.



Technical Data

Pressure ratings are for properly grooved Swagelok PFA tubing used with Swagelok PFA tube fittings and for Swagelok PFA tubing used with metal Swagelok tube fittings.

Fractional Tubing

Tubing Wall, in.	0.030		0.047		0.062			
Nominal Tube Size in.	1/8	1/4	1/4	3/8	1/2	3/4	1	
Temperature °F (°C)	Working Pressure psig (bar)							
70 (20)	275 (18.9)	200 (13.7)	275 (18.9)	180 (12.4)	125 (8.6)	83 (5.7)	61 (4.2)	
100 (37)	245 (16.8)	180 (12.4)	245 (16.8)	155 (10.6)	115 (7.9)	73 (5.0)	54 (3.7)	
200 (93)	145 (9.9)	110 (7.5)	145 (9.9)	93 (6.4)	68 (4.6)	43 (2.9)	32 (2.2)	
300 (148)	87 (5.9)	64 (4.4)	87 (5.9)	48 (3.3)	32 (2.2)	19 (1.3)	13 (0.89)	
400 (204)	47 (3.2)	34 (2.3)	47 (3.2)	11 (0.75)	11 (0.75)	5.0 (0.34)	3.0 (0.20)	

Metric Tubing

Tubing Wall, mm	1				1.5			
Nominal Tube Size mm	6	8	10	12	6	8	10	12
Temperature °C (°F)	Working Pressure bar (psig)							
20 (70)	12 (174)	8.9 (129)	7.0 (101)	5.7 (82)	19 (275)	14 (203)	11 (159)	8.9 (129)
50 (122)	9.7 (140)	7.1 (103)	5.5 (79)	4.6 (66)	15 (217)	11 (159)	8.7 (126)	7.1 (103)
100 (212)	6.1 (88)	4.4 (63)	3.4 (49)	2.8 (40)	9.5 (137)	6.9 (100)	5.3 (76)	4.4 (63)
150 (302)	3.8 (55)	2.5 (36)	1.8 (26)	1.4 (20)	5.9 (85)	4.0 (58)	2.9 (42)	2.2 (31)
200 (392)	2.2 (31)	1.3 (18)	0.8 (11)	0.6 (8.7)	3.4 (49)	2.0 (29)	1.3 (18)	0.9 (13)

Cleaning and Packaging

Swagelok PFA tubing is cleaned in accordance with Swagelok *Standard Cleaning and Packaging (SC-10)* catalog, [MS-06-62](#). Each tube length is bagged individually and boxed.

PFA Series PFA Tubing

Ordering Information

Select an ordering number.



Nominal Tube Size	Length	Ordering Number	Nominal Wall Thickness
Dimensions	ft (m)		in.
1/8 in.	100 (30.5)	PFA-T2-030-100	0.030
	500 (152)	PFA-T2-030-500	
1/4 in.	100 (30.5)	PFA-T4-047-100	0.047
		PFA-T4-062-100	0.062
3/8 in.	50 (15.2)	PFA-T6-062-50	0.062
	100 (30.5)	PFA-T6-062-100	
1/2 in.	50 (15.2)	PFA-T8-062-50	0.062
	100 (30.5)	PFA-T8-062-100	
3/4 in.	50 (15.2)	PFA-T12-062-50	0.062
1 in.	50 (15.2)	PFA-T16-062-50	0.062
Dimensions	m (ft)		mm
6 mm	30 (98.4)	PFA-T6M-1M-30M	1.0
		PFA-T6M-1.5M-30M	1.5
8 mm		PFA-T8M-1M-30M	1.0
		PFA-T8M-1.5M-30M	1.5
10 mm		PFA-T10M-1M-30M	1.0
		PFA-T10M-1.5M-30M	1.5
12 mm		PFA-T12M-1M-30M	1.0
		PFA-T12M-1.5M-30M	1.5

PFA Tube Fittings



Swagelok PFA tube fittings in sizes from 1/8 to 1/2 in. are available for use with PFA tubing. Refer to *Swagelok PFA tube fittings* catalog, [MS-01-05](#), for additional information.

Ultrahigh-Purity PFA Tubing (PFA4 and PFA9D)



Swagelok PFA tubing is available in ultrahigh-purity (PFA4) and advanced (fluorosurfactant resistant) ultrahigh-purity (PFA9D) grades. Refer to *Ultrahigh-Purity PFA Tubing—PFA4 and PFA9D* catalog, [MS-02-196](#), for additional information.

High-Purity PFA Fine Thread Flare Tube Fittings



Swagelok high-purity PFA fine thread flare fittings in sizes from 1/4 to 1 in. are available for use with PFA tubing. Refer to *High-Purity PFA Fine Thread Flare Tube Fittings* catalog, [MS-02-195](#), for additional information.

Groove Cutter

⚠ PFA tubing MUST be grooved for use with PFA tube fittings. Use the Swagelok groove cutter tool. It is not necessary to groove tubing for use with metal fittings.

Groove PFA tubing for use with Swagelok PFA tube fittings.



For 1/4, 3/8,
and 1/2 in. tubing



For 1/8 in.
tubing

Tube Size in.	Ordering Number
1/8	MS-GC-2
1/4	MS-GC-4
3/8	MS-GC-6
1/2	MS-GC-8

LT Series Vinyl Tubing

Features

- General purpose, clear vinyl, flexible tubing.
- Smooth-bore, polyvinyl chloride (PVC) material.
- Size range of 1/8 through 1/2 in.
- Can be used with Swagelok tube fitting and metal insert.
- Good for a variety of applications where system transparency is desired.
- Bulk tubing and end connections available for field assembly.
- Thick-wall tubing available in 1/4 and 3/8 in. sizes for vacuum-service applications.

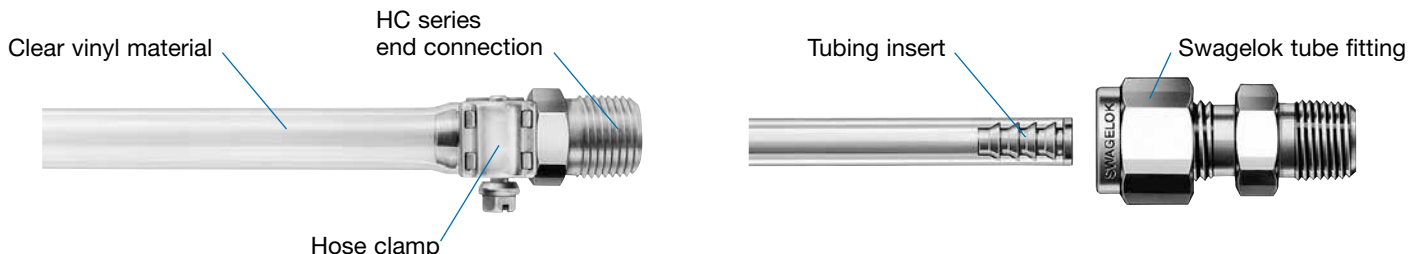

Technical Data and Ordering Information

- Pressure ratings are based on tubing used with an HC series end connection secured by a clamp or with a Swagelok tube fitting and metal insert.
- Tubing is sold in 50 ft (15.2 m) rolls.
- Select an ordering number.

Nominal Inside Diameter in.	Nominal Outside Diameter in.	Temperature Range °F (°C)	Working Pressure at 70°F (20°C) psig (bar)	Bulk Tubing Weight lb/ft (kg/m)	Ordering Number
Standard Wall					
1/8	1/4	-40 to 165 (-40 to 73)	40 (2.7)	0.02 (0.03)	LT-2-4
3/16	5/16		30 (2.0)	0.03 (0.04)	LT-3-5
1/4	3/8		25 (1.7)	0.04 (0.05)	LT-4-6
3/8	1/2		15 (1.0)	0.05 (0.07)	LT-6-8
1/2	5/8		10 (0.68)	0.06 (0.08)	LT-8-10
Thick-Wall Vacuum					
1/4	5/8	-40 to 165 (-40 to 73)	Vacuum service over entire temperature range	0.13 (0.20)	LT-4-10V
3/8	7/8			0.27 (0.41)	LT-6-14V



Pressure-Temperature Ratings

Nominal Tubing Size in.	Standard Wall				
	1/8	3/16	1/4	3/8	1/2
Temperature °F (°C)	Working Pressure, psig (bar)				
-40 (-40) to 70 (20)	40 (2.7)	30 (2.0)	25 (1.7)	15 (1.0)	10 (0.68)
80 (26)	38 (2.6)	29 (1.9)	24 (1.6)	14 (1.0)	10 (0.68)
100 (37)	32 (2.2)	24 (1.6)	20 (1.3)	12 (0.82)	8.0 (0.55)
120 (48)	24 (1.6)	18 (1.2)	15 (1.0)	9.0 (0.62)	6.0 (0.41)
140 (60)	16 (1.1)	12 (0.82)	10 (0.68)	6.0 (0.41)	4.0 (0.27)
160 (71)	8.4 (0.57)	6.3 (0.43)	5.3 (0.36)	3.2 (0.21)	2.1 (0.14)
165 (73)	6.4 (0.44)	4.8 (0.33)	4.0 (0.27)	2.4 (0.16)	1.6 (0.11)

Cleaning and Packaging

Swagelok vinyl tubing is cleaned in accordance with Swagelok *Standard Cleaning and Packaging (SC-10)* catalog, [MS-06-62](#). Each roll of tubing is coiled individually and boxed.

HC Series—End Connections for Soft Tubing and Hose

Features

- HC series end connections allow for easy installation of soft plastic or rubber tubing.
- 316 stainless steel or brass material.
- Size range of 1/8 to 1 in.
- Reusable for other assemblies.
- May be used without a hose clamp or sleeve in low-pressure applications.
- Use of a hose clamp or sleeve may be required in higher-pressure applications.

Ordering Information

Add **SS** for 316 stainless steel or **B** for brass to the basic ordering number. Availability of brass may vary based on end connections.

Example: **SS-2-HC-1-2**

For end connection barb dimensions, see page 88. To determine the cut length of bulk hose for field assembly, subtract dimension *B* for each end connection from the desired overall length.

Male Pipe Threads, NPT and ISO/BSP Tapered (ISO 7)

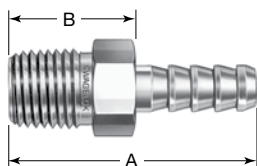

NPT and ISO/BSP Tapered Size in.	Nominal Tubing ID in.	Basic Ordering Number	Dimensions, in. (mm)			
			A	B	Minimum Inside Diameter	Maximum Outside Dimension
NPT						
1/8	1/8	-2-HC-1-2	1.08 (27.4)	0.68 (17.3)	0.13 (3.3)	0.51 (12.9)
	3/16	-3-HC-1-2	1.27 (32.2)		0.13 (3.3)	
	1/4	-4-HC-1-2	1.47 (37.3)		0.19 (4.8)	
	5/16	-5-HC-1-2	1.55 (39.4)		0.19 (4.8)	
1/4	1/8	-2-HC-1-4	1.26 (32.0)	0.86 (21.8)	0.08 (2.0)	0.65 (16.6)
	3/16	-3-HC-1-4	1.45 (36.8)		0.13 (3.3)	
	1/4	-4-HC-1-4	1.65 (41.9)		0.19 (4.8)	
	5/16	-5-HC-1-4	1.73 (43.9)		0.19 (4.8)	
	3/8	-6-HC-1-4	1.73 (43.9)		0.30 (7.6)	0.80 (20.3)
	1/2	-8-HC-1-4	1.80 (45.7)		0.28 (7.1)	
3/8	1/4	-4-HC-1-6	1.66 (42.2)	0.87 (22.1)	0.19 (4.8)	0.80 (20.3)
	5/16	-5-HC-1-6	1.74 (44.2)	0.87 (22.1)	0.19 (4.8)	
	3/8	-6-HC-1-6	1.74 (44.2)	0.87 (22.1)	0.30 (7.6)	
	1/2	-8-HC-1-6	1.81 (46.0)	0.87 (22.1)	0.38 (9.7)	
	5/8	-10-HC-1-6	1.88 (47.8)	0.90 (22.9)	0.38 (9.7)	1.23 (31.2)
1/2	1/4	-4-HC-1-8	1.85 (47.0)	1.06 (26.9)	0.19 (4.8)	1.02 (25.8)
	5/16	-5-HC-1-8	1.96 (49.8)	1.09 (27.7)	0.19 (4.8)	
	3/8	-6-HC-1-8	1.96 (49.8)	1.09 (27.7)	0.30 (7.6)	
	1/2	-8-HC-1-8	2.03 (51.6)	1.09 (27.7)	0.38 (9.7)	
	5/8	-10-HC-1-8	2.07 (52.6)	1.09 (27.7)	0.47 (11.9)	1.23 (31.2)
	3/4	-12-HC-1-8	2.14 (54.4)	1.09 (27.7)	0.47 (11.9)	
3/4	5/8	-10-HC-1-12	2.07 (52.6)	1.09 (27.7)	0.50 (12.7)	1.23 (31.2)
	3/4	-12-HC-1-12	2.14 (54.4)	1.09 (27.7)	0.63 (16.0)	
	1	-16-HC-1-12	2.38 (60.5)	1.19 (30.2)	0.63 (16.0)	1.60 (40.5)
1	3/4	-12-HC-1-16	2.43 (61.7)	1.38 (35.1)	0.63 (16.0)	1.60 (40.5)
	1	-16-HC-1-16	2.57 (65.3)		0.88 (22.4)	
ISO/BSP Tapered						
1/8	1/8	-2-HC-1-2RT	1.28 (32.5)	0.88 (22.4)	0.08 (2.0)	0.51 (12.9)
	1/4	-4-HC-1-2RT	1.47 (37.3)	0.68 (17.3)	0.19 (4.8)	
1/4	1/4	-4-HC-1-4RT	1.65 (41.9)	0.86 (21.8)	0.19 (4.8)	0.65 (16.6)
	3/8	-6-HC-1-4RT	1.73 (43.9)		0.30 (7.6)	
3/8	1/4	-4-HC-1-6RT	1.66 (42.2)	0.87 (22.1)	0.30 (7.6)	0.80 (20.3)
	3/8	-6-HC-1-6RT	1.74 (44.2)		0.30 (7.6)	
1/2	3/8	-6-HC-1-8RT	1.96 (49.8)	1.09 (27.7)	0.30 (7.6)	1.02 (25.8)
	1/2	-8-HC-1-8RT	2.03 (51.6)		0.38 (9.7)	

HC Series—End Connections for Soft Tubing and Hose

Female Pipe Threads, NPT

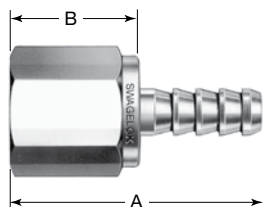

NPT Size in.	Nominal Tubing ID in.	Basic Ordering Number	Dimensions, in. (mm)			
			A	B	Minimum Inside Diameter	Maximum Outside Dimension
1/8	1/8	-2-HC-7-2	1.11 (28.2)	0.71 (18.0)	0.08 (2.0)	0.65 (16.6)
	3/16	-3-HC-7-2	1.29 (32.8)	0.70 (17.8)	0.13 (3.3)	
	1/4	-4-HC-7-2	1.47 (37.3)	0.68 (17.3)	0.19 (4.8)	
1/4	1/8	-2-HC-7-4	1.26 (32.0)	0.86 (21.8)	0.08 (2.0)	0.87 (22.1)
	3/16	-3-HC-7-4	1.44 (36.6)	0.85 (21.6)	0.13 (3.3)	
	1/4	-4-HC-7-4	1.64 (41.7)	0.85 (21.6)	0.19 (4.8)	
	5/16	-5-HC-7-4	1.73 (43.9)	0.86 (21.8)	0.19 (4.8)	
	3/8	-6-HC-7-4	1.69 (42.9)	0.82 (20.8)	0.30 (7.6)	
3/8	1/4	-4-HC-7-6	1.71 (43.4)	0.92 (23.4)	0.19 (4.8)	1.02 (25.8)
	5/16	-5-HC-7-6	1.82 (46.2)	0.95 (24.1)	0.19 (4.8)	
	3/8	-6-HC-7-6	1.78 (45.2)	0.91 (23.1)	0.30 (7.6)	
1/2	3/8	-6-HC-7-8	2.03 (51.6)	1.16 (29.5)	0.30 (7.6)	1.23 (31.2)
	1/2	-8-HC-7-8	2.13 (54.1)	1.19 (30.2)	0.38 (9.7)	

Swagelok Tube Adapters

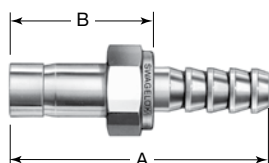

Tube Adapter Size	Nominal Tubing ID	Basic Ordering Number	Dimensions			
			A	B	Minimum Inside Diameter	Maximum Outside Dimension
Dimensions, in. (mm)						
1/8	1/8	-2-HC-A-201	1.36 (34.5)	0.96 (24.4)	0.08 (2.0)	0.36 (9.2)
1/4	1/8	-2-HC-A-401	1.45 (36.8)	1.05 (26.7)	0.08 (2.0)	0.44 (11.0)
	1/4	-4-HC-A-401	1.85 (47.0)	1.06 (26.9)	0.16 (4.1)	0.51 (12.9)
	5/16	-5-HC-A-401	1.93 (49.0)			0.51 (12.9)
	3/8	-6-HC-A-401	1.93 (49.0)			0.65 (16.6)
3/8	1/4	-4-HC-A-601	1.91 (48.5)	1.12 (28.4)	0.19 (4.8)	0.51 (12.9)
	3/8	-6-HC-A-601	1.99 (50.5)		0.27 (6.9)	0.65 (16.6)
	1/2	-8-HC-A-601	2.06 (52.3)			0.80 (20.3)
1/2	3/8	-6-HC-A-811	2.25 (57.2)	1.38 (35.1)	0.30 (7.6)	0.73 (18.4)
	1/2	-8-HC-A-811	2.32 (58.9)		0.33 (8.4)	0.80 (20.3)
3/4	3/4	-12-HC-A-1211	2.49 (63.3)	1.44 (36.6)	0.58 (14.7)	1.23 (31.2)
1	1	-16-HC-A-1611	3.05 (77.5)	1.86 (47.2)	0.80 (20.3)	1.60 (40.5)
Dimensions, mm (in.)						
6	1/4 in.	-4-HC-A-6MTA	47.8 (1.88)	27.7 (1.09)	4.1 (0.16)	12.9 (0.51)

Swagelok tube adapters are to be used only with Swagelok tube fittings.

Swagelok Tube Fittings

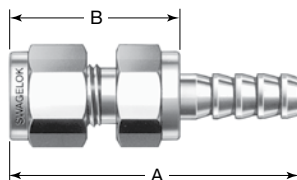

Tube Fitting Size in.	Nominal Tubing ID in.	Basic Ordering Number	Dimensions, in. (mm)			
			A	B	Minimum Inside Diameter	Maximum Outside Dimension
1/8	1/8	-2-HC-1-200	1.42 (36.1)	1.02 (25.9)	0.08 (2.0)	0.51 (12.9)
	1/4	-4-HC-1-200	1.81 (46.0)		0.09 (2.3)	
1/4	1/4	-4-HC-1-400	1.92 (48.8)	1.13 (28.7)	0.19 (4.8)	0.65 (16.6)
	3/8	-6-HC-1-400	1.99 (50.5)	1.12 (28.5)		
3/8	3/8	-6-HC-1-600	2.06 (52.3)	1.19 (30.2)	0.28 (7.1)	0.87 (22.1)
1/2	1/2	-8-HC-1-810	2.24 (56.9)	1.30 (33.0)	0.38 (9.7)	1.02 (25.8)

HC Series—End Connections for Soft Tubing and Hose

Sanitary Kwik-Clamps

- Smooth internal finish (20 μ in. R_a) and tapered orifice reduce entrapment and facilitate cleaning.

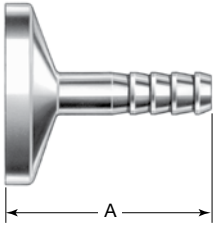

Kwik-Clamp Size in.	Nominal Tubing ID in.	Ordering Number	Dimensions, in. (mm)		
			A	Minimum Inside Diameter	Maximum Outside Dimension
1/2	3/16	SS-3-HC-8SC	1.10 (27.9)	0.13 (3.3)	0.99 (25.1)
	1/4	SS-4-HC-8SC	1.28 (32.5)	0.19 (4.8)	
	3/8	SS-6-HC-8SC	1.36 (34.5)	0.30 (7.6)	
	1/2	SS-8-HC-8SC ^①	1.44 (36.6)	0.38 (9.7)	
1	3/16	SS-3-HC-16SC	1.50 (38.1)	0.13 (3.3)	1.98 (50.3)
	1/4	SS-4-HC-16SC		0.19 (4.8)	
	3/8	SS-6-HC-16SC		0.30 (7.6)	
	1/2	SS-8-HC-16SC		0.38 (9.7)	

① Without 30° inside diameter taper.

End Connection Barb Dimensions

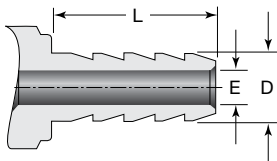

Nominal Tubing ID, in.	Dimensions, in. (mm)		
	D	E	L
1/8	0.15 (3.7)	0.08 (2.0)	0.40 (9.8)
3/16	0.23 (5.6)	0.12 (2.9)	0.59 (14.5)
1/4	0.30 (7.4)	0.19 (4.7)	0.79 (19.4)
5/16	0.38 (9.3)	0.19 (4.7)	0.87 (21.3)
3/8	0.45 (11.0)	0.30 (7.4)	0.87 (21.3)
1/2	0.60 (14.7)	0.38 (9.3)	0.94 (23.0)
5/8	0.75 (19.0)	0.50 (12.7)	0.98 (24.0)
3/4	0.90 (22.0)	0.63 (15.4)	1.05 (25.7)
1	1.20 (29.4)	0.88 (21.6)	1.19 (29.2)

Sleeves, Clamps, and Inserts

Hose Connector Sleeves

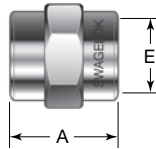

- Used to secure soft plastic or rubber tubing to hose connectors.
- Constructed of aluminum.
- Helically grooved ID and outer hex allow for easy installation with a wrench.
- Reusable for other assemblies.

Hose OD in.	Hose ID in.	Ordering Number	Dimensions, in. (mm)		
			A	E	Maximum Outside Dimension
1/4	1/8	A-2-L-4	0.40 (10.2)	0.26 (6.6)	0.44 (11.0)
3/8	1/4	A-4-L-6	0.79 (20.1)	0.41 (10.4)	0.65 (16.6)
7/16	1/4	A-4-L-7		0.46 (11.7)	0.73 (18.4)
1/2	1/4	A-4-L-8	0.87 (22.1)	0.52 (13.2)	0.80 (20.3)
7/16	5/16	A-5-L-7		0.48 (12.2)	0.73 (18.4)
1/2	3/8	A-6-L-8	0.94 (23.9)	0.55 (14.0)	0.80 (20.3)
9/16	3/8	A-6-L-9		0.61 (15.5)	0.87 (22.1)
5/8	7/16	A-7-L-10	1.07 (27.2)	0.69 (17.5)	0.94 (23.9)
11/16	1/2	A-8-L-11		0.76 (19.3)	1.02 (25.8)
1	3/4	A-12-L-16	1.10 (27.9)	1.45 (36.8)	

Hose Clamps

- Material:
Band, saddle, housing: 304 SS
Screw: 304 SS / 305 SS
- 4-corner clinched saddle and housing with no spot welds to corrode or break.
- Smooth inside diameter surface provides high sealing pressure and reduces torque on screw.



Min Hose OD in.	Max Hose OD in.	Ordering Number	Band Marking
7/16	25/32	MS-HCC-6	6
1/2	29/32	MS-HCC-8	8
9/16	1 1/16	MS-HCC-10	10
11/16	1 1/4	MS-HCC-12	12
13/16	1 1/2	MS-HCC-16	16

Tubing Inserts

- Tubing inserts help secure soft plastic tubing used with standard Swagelok tube fittings.
- Some tubing inserts may be non-barbed depending on size and material.
- For materials, ordering information, and dimensions, refer to *Gaugeable Tube Fittings and Adapter Fittings* catalog, [MS-01-140](#).



NG Series Nylon Hose

Features

- Designed for use with natural gas where static dissipation is required.
- Static dissipative, smooth-bore nylon core.
- Size range of 1/4, 3/8 and 1/2 in. and working pressures up to 5000 psig (344 bar).
- Internal fiber reinforcement enhances hose pressure rating.
- Perforated polyurethane cover resists abrasion.
- Single, twin bonded, and vent bonded hoses are available in custom assemblies.
- Most popular configurations are available with NGV3.1-2014 Class B and NGV4.2-2014 Class A certification.
- For electrical properties, see page 5 for details.

Single hose



Twin hose (high-pressure vent)



Vent hose (low-pressure vent)

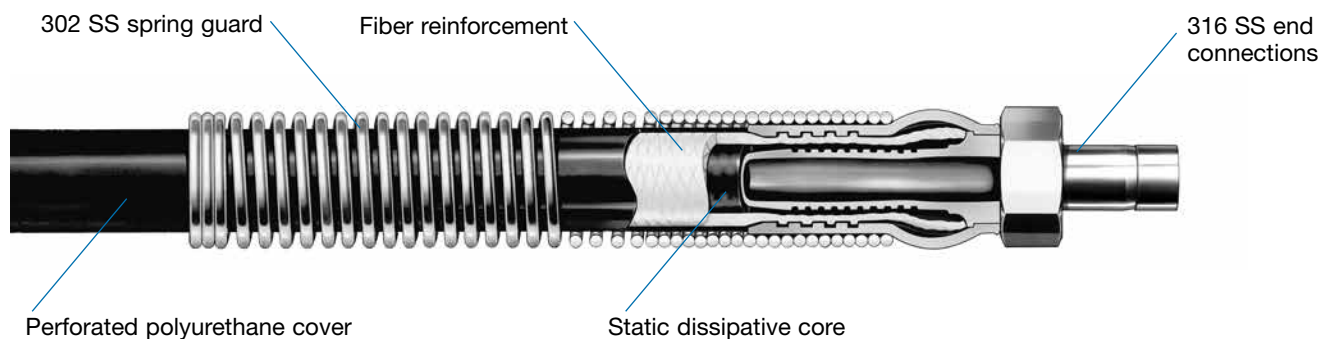

Technical Data

Hose Style (Series)	Nominal Hose Size in. (mm)	Inside Diameter in. (mm)	Outside Diameter in. (mm)	Minimum Inside Bend Radius in. (cm)	Temperature Range °F (°C)	Working Pressure at 70°F (20°C) psig (bar)	Minimum Burst Pressure at 70°F (20°C) psig (bar)	Bulk Hose Weight lb/ft (kg/m)
Single (NGS)	1/4 (6.4)	0.26 (6.6)	0.63 (16.0)	2.00 (5.08)	-40 to 150 (-40 to 65)	5000 (344)	20 000 (1378)	0.12 (0.17)
	3/8 (9.6)	0.38 (9.6)	0.77 (19.6)	4.00 (10.2)				0.15 (0.22)
	1/2 (12.7)	0.52 (13.2)	0.89 (22.6)	5.50 (14.0)				0.21 (0.32)
Twin (NGT)	1/4 (6.4)	0.26 (6.6)	0.63 (16.0)	2.00 (5.08)		Fill and vent 5000 (344)	Fill and vent 20 000 (1378)	0.25 (0.37)
	3/8 (9.6)	0.38 (9.6)	0.77 (19.6)	4.00 (10.2)				0.30 (0.44)
Vent ^① (NGV)	1/4 (6.4)	Fill 0.26 (6.6) Vent 0.26 (6.6)	Fill 0.63 (16.0) Vent 0.63 (16.0)	2.00 (5.08)		Fill 5000 (344) Vent 1500 (103)	Fill 20 000 (1378) Vent 6 000 (413)	0.15 (0.22)
	3/8 (9.6)	Fill 0.38 (9.6) Vent 0.26 (6.6)	Fill 0.77 (19.6) Vent 0.63 (16.0)	4.00 (10.2)	0.25 (0.37)			

① Low-pressure vent line does not have static dissipative core.

Testing

Every Swagelok NG series hose assembly is pressure tested with water at room temperature for 30 seconds to a requirement of no detectable leakage. Testing is performed at 5000 psig (344 bar). Every Swagelok NG series hose assembly is factory tested for electrical conductivity.

Cleaning and Packaging

Swagelok conductive core hose components are cleaned in accordance with Swagelok *Standard Cleaning and Packaging (SC-10)* catalog, [MS-06-62](#). Each hose is bagged individually and boxed; longer hoses are coiled, bagged, and boxed.

swagelok.com



Warning:

All equipment must be properly grounded to allow static dissipation and help to prevent static sparking.

Periodic inspection of hose assembly is recommended. End-to-end electrical resistance of the hose assembly must not exceed 1 MΩ per meter when tested at 500 VDC.

Swagelok

NG Series Nylon Hose

Ordering Information and Dimensions

Custom Hose Assemblies—Single Hose

Build a hose assembly ordering number by combining the designators in the sequence shown below.



Typical Ordering Number

1 2 3 4 4 5 6
 SS - NGS 4 - T6 S4 - 40 - F

1 Material

End Connections

SS = 316 stainless steel

2 Hose

NGS = NG series single nylon hose

3 Nominal Hose Size, in.

4 = 1/4

6 = 3/8

8 = 1/2

4 End Connections

See **End Connection Designator** column in tables on page 92.

For fitting dimensions, see **End Connection** tables, page 92.

5 Overall Length

Insert length in inches.

6 Options

For multiple options, add designators in alphanumeric order with a dash between each designator.

F = Fire jacket

F1 = Thermosleeve

N3 = Nitrogen pressure test

X = No spring guards^①

NGV = NGV 3.1 and 4.2 certified

W = Hydrostatic test

^① 5 in. spring guards at each end are standard. The X option should only be used in static bend applications.

Mat Tags

MA = Gray

MO = Orange

MB = Blue

MP = Purple

MC = Brown

MR = Red

MG = Green

MW = White

MK = Black

MY = Yellow

MN = Pink

Add 2 to the end of the Mat Tag designator for two tags.

Example: MA2

See page 107 for detailed descriptions of options.

NG Series Nylon Hose

Ordering Information and Dimensions

Custom Hose Assemblies—Twin and Vent Hoses

Build a hose assembly ordering number by combining the designators in the sequence shown below.

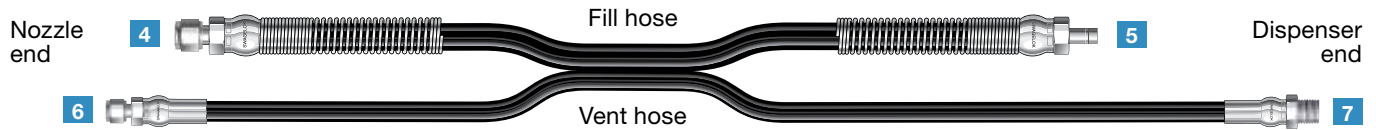

Typical Ordering Number

1 2 3 4 5 6 7 8 9 10 11
 SS - NGV 6 - S6 T6 S4 P6 - 48 - 1 3 - X

1 Material

End Connections

SS = 316 stainless steel

2 Hose

NGT = NG series twin nylon hose

NGV = NG series vent nylon hose

3 Nominal Fill Hose Size, in.

4 = 1/4

6 = 3/8

4 Fill Hose Nozzle End Connection

5 Fill Hose Dispenser End Connection

6 Vent Hose Nozzle End Connection

7 Vent Hose Dispenser End Connection

See **End Connection Designator** column in tables on page 92.

For fitting dimensions, see **End Connection** tables, page 92.

8 Overall Length (Fill)

Insert length in inches.

9 Vent Hose Nozzle End Length Adjustment

Positive

X = None

1 = 2 in.

2 = 4 in.

3 = 6 in.

4 = 8 in.

5 = 10 in.

6 = 12 in.

7 = 15 in.

8 = 18 in.

9 = 21 in.

0 = 24 in.

Negative

X = None

A = 2 in.

B = 4 in.

C = 6 in.

D = 8 in.

E = 10 in.

F = 12 in.

G = 15 in.

H = 18 in.

J = 21 in.

K = 24 in.

Illustration shows adjustment 1.

10 Vent Hose Dispenser End Length Adjustment

Positive

X = None

1 = 2 in.

2 = 4 in.

3 = 6 in.

4 = 8 in.

5 = 10 in.

6 = 12 in.

7 = 15 in.

8 = 18 in.

9 = 21 in.

0 = 24 in.

Negative

X = None

A = 2 in.

B = 4 in.

C = 6 in.

D = 8 in.

E = 10 in.

F = 12 in.

G = 15 in.

H = 18 in.

J = 21 in.

K = 24 in.

Illustration shows adjustment 3.

11 Options

For multiple options, add designators in alphanumeric order with a dash between each designator.

5 in. spring guards at each end are standard.

N3 = Nitrogen pressure test

X = No spring guards^①

NGV = NGV 3.1 and 4.2 certified (NGT hose only)

W = Hydrostatic test

^① This option should only be used in static bend applications.

NG Series Nylon Hose

End Connections

Swagelok Tube Fittings



Tube Fitting Size	Nominal Hose Size	End Connection Designator	Dimensions		
			A	Minimum Inside Diameter	Maximum Outside Dimension
Dimensions, in. (mm)					
1/4	1/4	S4 ^①	2.57 (65.3)	0.15 (3.8)	0.80 (20.3)
3/8	3/8	S6 ^①	2.94 (74.7)	0.24 (6.1)	0.87 (22.1)
1/2	1/2	S8 ^①	3.30 (83.8)	0.36 (9.1)	1.16 (29.5)
Dimensions, mm (in.)					
6	1/4 in.	G6 ^①	65.5 (2.57)	3.8 (0.15)	20.3 (0.80)
8		G8 ^①	65.5 (2.58)	3.8 (0.15)	20.3 (0.80)
10	3/8 in.	G1 ^①	74.9 (2.95)	6.1 (0.24)	22.1 (0.87)
12	1/2 in.	G2 ^①	83.8 (3.30)	9.1 (0.36)	29.5 (1.16)

① NGV 3.1 and 4.2 certification available.

Swagelok Tube Adapters



Tube Adapter Size	Nominal Hose Size	End Connection Designator	Dimensions		
			A	Minimum Inside Diameter	Maximum Outside Dimension
Dimensions, in. (mm)					
1/4	1/4	T4 ^①	2.48 (63.0)	0.15 (3.8)	0.80 (20.3)
3/8	1/4	T6 ^①	2.47 (62.7)	0.15 (3.8)	0.80 (20.3)
	3/8	T6 ^①	2.82 (71.6)	0.24 (6.1)	0.87 (22.1)
1/2		T8 ^①	3.20 (81.3)	0.28 (7.1)	1.09 (27.7)
	5/8	1/2	T8 ^①	3.40 (86.4)	0.36 (9.1)
T5 ^①			3.40 (86.4)	0.39 (9.9)	1.09 (27.7)
3/4		T7	3.70 (94.0)	0.56 (14.2)	1.31 (33.1)
Dimensions, mm (in.)					
6	1/4 in.	E6 ^①	65.3 (2.57)	3.8 (0.15)	20.3 (0.80)
8		E8 ^①	62.7 (2.47)	3.8 (0.15)	20.3 (0.80)
10	3/8 in.	E1 ^①	71.6 (2.82)	6.1 (0.24)	22.1 (0.87)
12	1/2 in.	E2 ^①	86.4 (3.40)	9.1 (0.36)	29.5 (1.16)

① NGV 3.1 and 4.2 certification available.

NG Series Nylon Hose

End Connections

Male Pipe Threads, NPT and ISO/BSP Tapered (ISO 7)



NPT and ISO/BSP Tapered Size in.	Nominal Hose Size in.	End Connection Designator	Dimensions, in. (mm)		
			A	Minimum Inside Diameter	Maximum Outside Dimension
NPT					
1/4	1/4	P4 ^①	2.28 (57.9)	0.15 (3.8)	0.80 (20.3)
	3/8	P4 ^①	2.65 (67.3)	0.24 (6.1)	0.87 (22.1)
3/8		P6 ^①	2.65 (67.3)	0.24 (6.1)	0.87 (22.1)
1/2	1/2	P8 ^①	3.09 (78.5)	0.36 (9.1)	1.16 (29.5)
ISO/BSP Tapered					
1/4	1/4	K4	2.28 (57.9)	0.15 (3.8)	0.80 (20.3)
3/8	3/8	K6	2.65 (67.3)	0.24 (6.1)	0.87 (22.1)
1/2	1/2	K8	3.09 (78.5)	0.36 (9.1)	1.16 (29.5)

① NGV 3.1 and 4.2 certification available.

SAE 37° (JIC) Female Swivel

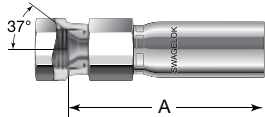

Swivel Size in.	Nominal Hose Size in.	End Connection Designator	Dimensions, in. (mm)		
			A	Minimum Inside Diameter	Maximum Outside Dimension
1/4	1/4	A4 ^①	2.28 (57.9)	0.15 (3.8)	0.80 (20.3)
3/8	3/8	A6 ^①	2.65 (67.3)	0.24 (6.1)	0.87 (22.1)
1/2	1/2	A8 ^①	2.90 (73.7)	0.36 (9.1)	1.09 (27.7)

① NGV 3.1 and 4.2 certification available.

7R and 8R Series Nylon Hose

Features

- SAE general-purpose, hydraulic, nylon hose.
- Smooth-bore nylon core.
- Size range of 1/4 to 1/2 in. and working pressures up to 5000 psig (344 bar).
- Internal fiber reinforcement enhances hose pressure rating.
- Smooth black polyurethane cover is perforated to prevent blistering.
- Polyurethane cover resists abrasion.
- Select 8R series hose assemblies are approved to ECE R110; see page 110 for more information.
- Designed for use in hydraulic applications where outgassing is a concern.
- Options include hose covers and spring guard. See page 107 for details.
- For electrical properties, see page 5 for details.

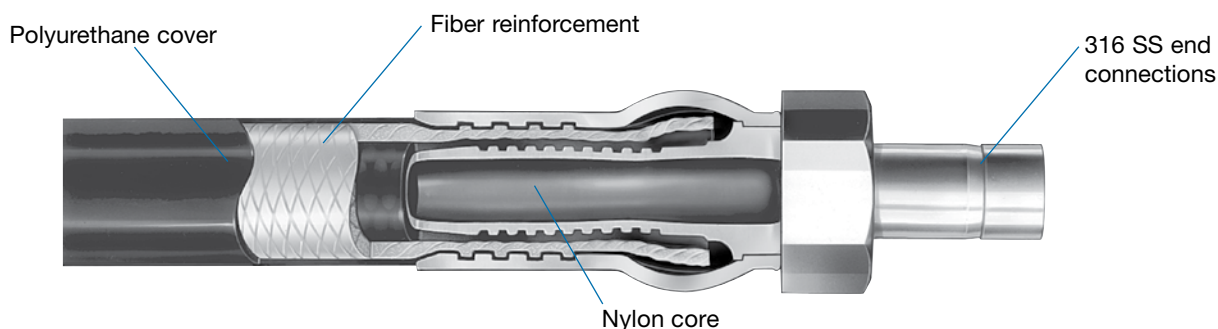

Technical Data

Specification (Series)	Nominal Hose Size in. (mm)	Inside Diameter in. (mm)	Outside Diameter in. (mm)	Minimum Inside Bend Radius in. (cm)	Temperature Range °F (°C)	Working Pressure at 70°F (20°C) psig (bar)	Minimum Burst Pressure at 70°F (20°C) psig (bar)	Bulk Hose Weight lb/ft (kg/m)
SAE J517 100R7 (7R series)	1/4 (6.4)	0.27 (7.1)	0.48 (12.2)	1.25 (3.18)	-40 to 200 (-40 to 93)	2750 (189)	11 000 (757)	0.07 (0.10)
	3/8 (9.6)	0.39 (9.9)	0.64 (16.3)	2.00 (5.08)		2250 (155)	9 000 (620)	0.10 (0.15)
	1/2 (12.7)	0.53 (13.5)	0.81 (20.6)	3.00 (7.62)		2000 (137)	8 000 (551)	0.14 (0.21)
SAE J517 100R8 (8R series)	1/4 (6.4) ^①	0.25 (6.4)	0.53 (13.5)	2.00 (5.08)	-40 to 200 (-40 to 93)	5000 (344) ^②	20 000 (1378)	0.08 (0.12)
	3/8 (9.6)	0.38 (9.8)	0.67 (17.0)	2.50 (6.35)		4000 (275)	16 000 (1102)	0.11 (0.16)
	1/2 (12.7)	0.50 (12.7)	0.84 (21.3)	4.00 (10.2)		3500 (241)	14 000 (964)	0.15 (0.22)

^① 1/4 in. (6.4 mm) size does not meet SAE J517 impulse cycle requirements at maximum temperature and minimum bend radius.

^② Pressure-temperature ratings may be limited by the end connections.

Cleaning and Packaging

Swagelok nylon hose components are cleaned in accordance with Swagelok *Standard Cleaning and Packaging (SC-10)* catalog, [MS-06-62](#). Each hose is bagged individually and boxed; longer hoses are coiled, bagged, and boxed.

Ordering Information and Dimensions

- For custom hose assemblies, see page for 99 for hose sizes, end connections, lengths, and options.

7N Series Nylon Hose

Features

- SAE nonconductive, nylon hose.
- Smooth-bore nylon core.
- Size range of 1/4 to 1/2 in. and working pressures up to 2750 psig (189 bar).
- Internal fiber reinforcement enhances hose pressure rating.
- Smooth orange polyurethane cover is nonperforated to prevent moisture from entering hose.
- Polyurethane cover resists abrasion.
- Hose meets electrical conductivity requirements of SAE J343/SAE J517. Hose is not intended for exposure to continuous electrical current.
- Designed for use with petroleum-based and synthetic hydraulic fluids where SAE nonconductive properties are desired.
- Options include hose covers and spring guards. See page 107 for details.
- For electrical properties, see page 5 for details.

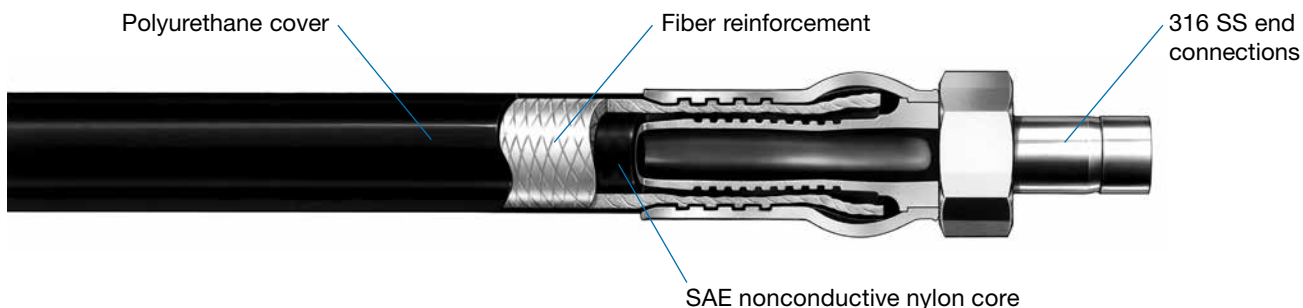

Technical Data

Specification (Series)	Nominal Hose Size in. (mm)	Inside Diameter in. (mm)	Outside Diameter in. (mm)	Minimum Inside Bend Radius in. (cm)	Temperature Range °F (°C)	Working Pressure at 70°F (20°C) psig (bar)	Minimum Burst Pressure at 70°F (20°C) psig (bar)	Bulk Hose Weight lb/ft (kg/m)
SAE J517 100R7 (7N series)	1/4 (6.4)	0.27 (7.1)	0.48 (12.2)	1.25 (3.18)	-40 to 200 (-40 to 93)	2750 (189)	11 000 (757)	0.07 (0.10)
	3/8 (9.6)	0.39 (9.9)	0.64 (16.3)	2.00 (5.08)		2250 (155)	9 000 (620)	0.10 (0.15)
	1/2 (12.7)	0.53 (13.5)	0.81 (20.6)	3.00 (7.62)		2000 (137)	8 000 (551)	0.14 (0.21)

Cleaning and Packaging

Swagelok nylon hose components are cleaned in accordance with Swagelok *Standard Cleaning and Packaging (SC-10)* catalog, [MS-06-62](#). Each hose is bagged individually and boxed; longer hoses are coiled, bagged, and boxed.

⚠ Caution:
System media can be conduits for electricity. Consider system media properties prior to use.

⚠ Nonperforated covers may blister in gas service.

Ordering Information and Dimensions

- For custom hose assemblies, see page for 99 for hose sizes, end connections, lengths, and options.

7R, 8R, and 7N Series Nylon Hose and 7P Series Polyethylene Hose

End Connections

Select an ordering number.

To determine the cut length of bulk hose for field assembly, subtract dimension *B* for each end connection from the desired overall length.

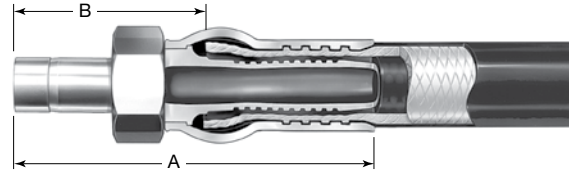

Swagelok Tube Adapters

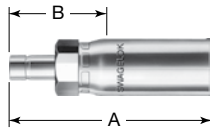

Tube Adapter Size	Nominal Hose Size	Ordering Number	Dimensions				End Connection Designator
			A	B	Minimum Inside Diameter	Maximum Outside Dimension	
Dimensions, in. (mm)							
1/4	1/4	SS-TP4-TA4	2.48 (63.0)	1.45 (36.8)	0.15 (3.8)	0.80 (20.3)	TA4 ^①
3/8	1/4	SS-TP4-TA6	2.47 (62.7)	1.44 (36.6)	0.15 (3.8)	0.80 (20.3)	TA6
	3/8	SS-TP6-TA6	2.82 (71.6)	1.51 (38.4)	0.24 (6.1)	0.87 (22.1)	TA6 ^①
1/2	1/2	SS-TP8-TA8	3.40 (86.4)	1.84 (46.7)	0.36 (9.1)	1.09 (27.7)	TA8 ^①
5/8	1/2	SS-TP8-TA10	3.40 (86.4)	1.84 (46.7)	0.39 (9.9)	1.09 (27.7)	TA10 ^①
Dimensions, mm (in.)							
6	1/4 in.	SS-TP4-TM6	63.0 (2.48)	36.8 (1.45)	3.8 (0.15)	20.3 (0.80)	TM6 ^①
8	1/4 in.	SS-TP4-TM8	62.7 (2.47)	36.6 (1.44)	3.8 (0.15)	20.3 (0.80)	TM8 ^①
10	3/8 in.	SS-TP6-TM10	71.6 (2.82)	38.4 (1.51)	6.1 (0.24)	22.1 (0.87)	TM10 ^①
12	1/2 in.	SS-TP8-TM12	86.4 (3.40)	46.7 (1.84)	9.1 (0.36)	27.7 (1.09)	TM12 ^①

^① ECE R110 approval available.

Swagelok Tube Fittings

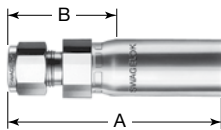

Tube Fitting Size	Nominal Hose Size	Ordering Number	Dimensions				End Connection Designator
			A	B	Minimum Inside Diameter	Maximum Outside Dimension	
Dimensions, in. (mm)							
1/4	1/4	SS-TP4-SL4	2.57 (65.3)	1.54 (39.1)	0.15 (3.8)	0.80 (20.3)	SL4 ^①
3/8	3/8	SS-TP6-SL6	2.94 (74.7)	1.63 (41.4)	0.24 (6.1)	0.87 (22.1)	SL6 ^①
1/2	1/2	SS-TP8-SL8	3.30 (83.8)	1.74 (44.2)	0.36 (9.1)	1.09 (27.7)	SL8 ^①
Dimensions, mm (in.)							
6	1/4 in.	SS-TP4-SM6	65.3 (2.57)	39.1 (1.54)	3.8 (0.15)	20.3 (0.80)	SM6 ^①
8	1/4 in.	SS-TP4-SM8	65.5 (2.58)	39.4 (1.55)	3.8 (0.15)	20.3 (0.80)	SM8 ^①
10	1/4 in.	SS-TP4-SM10	71.9 (2.83)	45.7 (1.80)	3.8 (0.15)	22.1 (0.87)	SM10
	3/8 in.	SS-TP6-SM10	74.9 (2.95)	41.7 (1.64)	6.1 (0.24)	22.1 (0.87)	SM10 ^①
12	1/2 in.	SS-TP8-SM12	83.8 (3.30)	44.2 (1.74)	9.1 (0.36)	27.7 (1.09)	SM12 ^①

^① ECE R110 approval available.

7R, 8R, and 7N Series Nylon Hose and 7P Series Polyethylene Hose

Male Pipe Threads,
NPT and ISO/BSP Tapered
(ISO 7)

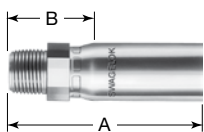

NPT and ISO/BSP Tapered Size in.	Nominal Hose Size in.	Ordering Number	Dimensions, in. (mm)				End Connection Designator
			A	B	Minimum Inside Diameter	Maximum Outside Dimension	
NPT							
1/4	1/4	SS-TP4-PM4	2.28 (57.9)	1.25 (31.8)	0.15 (3.8)	0.80 (20.3)	PM4 ^①
	3/8	SS-TP6-PM4	2.65 (67.3)	1.34 (34.0)	0.24 (6.1)	0.87 (22.1)	PM4 ^①
3/8	3/8	SS-TP6-PM6	2.65 (67.3)	1.34 (34.0)	0.24 (6.1)	0.87 (22.1)	PM6 ^①
1/2	1/2	SS-TP8-PM8	3.09 (78.5)	1.53 (38.9)	0.36 (9.1)	1.09 (27.7)	PM8 ^①
ISO/BSP Tapered							
1/4	1/4	SS-TP4-MT4	2.28 (57.9)	1.25 (31.8)	0.15 (3.8)	0.80 (20.3)	MT4 ^①
3/8	3/8	SS-TP6-MT6	2.65 (67.3)	1.34 (34.0)	0.24 (6.1)	0.87 (22.1)	MT6 ^①
1/2	1/2	SS-TP8-MT8	3.09 (78.5)	1.53 (38.9)	0.36 (9.1)	1.09 (27.7)	MT8 ^①

① ECE R110 approval available.

Male ISO/BSP Parallel
Threads with 60° Male
Cone (ISO 228)

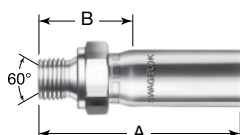

ISO/BSP Parallel, 60° Male Cone Size in.	Nominal Hose Size in.	Ordering Number	Dimensions, in. (mm)				End Connection Designator
			A	B	Minimum Inside Diameter	Maximum Outside Dimension	
1/4	1/4	SS-TP4-MS4	2.53 (64.3)	1.50 (38.1)	0.15 (3.8)	0.80 (20.3)	MS4
3/8	3/8	SS-TP6-MS6	2.73 (69.3)	1.42 (36.1)	0.24 (6.1)	0.87 (22.1)	MS6
1/2	1/2	SS-TP8-MS8	3.00 (76.2)	1.44 (36.6)	0.36 (9.1)	1.23 (31.2)	MS8

SAE 37° (JIC) Female
Swivel

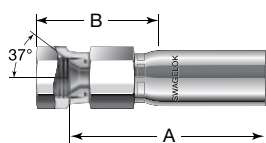

Swivel Size in.	Nominal Hose Size in.	Ordering Number	Dimensions, in. (mm)				End Connection Designator
			A	B	Minimum Inside Diameter	Maximum Outside Dimension	
1/4	1/4	SS-TP4-AS4	2.28 (57.9)	1.59 (40.4)	0.15 (3.8)	0.80 (20.3)	AS4
3/8	3/8	SS-TP6-AS6	2.65 (67.3)	1.71 (43.4)	0.24 (6.1)	0.87 (22.1)	AS6
1/2	1/2	SS-TP8-AS8	2.90 (73.7)	1.77 (45.0)	0.36 (9.1)	1.09 (27.7)	AS8

Dimensions shown with swivel nut pushed toward hex.

Female Swivel ISO/BSP
Parallel Threads with
60° Cone

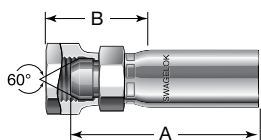

Swivel ISO/BSP Parallel Thread, 60° Cone Size in.	Nominal Hose Size in.	Ordering Number	Dimensions, in. (mm)				End Connection Designator
			A	B	Minimum Inside Diameter	Maximum Outside Dimension	
1/4	1/4	SS-TP4-BM4	2.28 (57.9)	1.42 (36.1)	0.15 (3.8)	0.87 (22.1)	BM4
3/8	3/8	SS-TP6-BM6	2.66 (67.6)	1.56 (39.6)	0.24 (6.1)	1.02 (25.8)	BM6
1/2	1/2	SS-TP8-BM8	2.90 (73.7)	1.67 (42.4)	0.36 (9.1)	1.23 (31.2)	BM8

Dimensions shown with swivel nut pushed toward hex.

7R, 8R, and 7N Series Nylon Hose and 7P Series Polyethylene Hose

SAE 37° (JIC) Male Flare

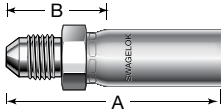

JIC Flare Size in.	Nominal Hose Size in.	Ordering Number	Dimensions, in. (mm)				End Connection Designator
			A	B	Minimum Inside Diameter	Maximum Outside Dimension	
1/4	1/4	SS-TP4-AN4	2.27 (57.7)	1.24 (31.5)	0.15 (3.8)	0.80 (20.3)	AN4 ^①
3/8	3/8	SS-TP6-AN6	2.60 (66.0)	1.29 (32.8)	0.28 (7.1)	0.87 (22.1)	AN6 ^①
1/2	1/2	SS-TP8-AN8	3.09 (78.5)	1.53 (38.9)	0.39 (9.9)	1.09 (27.7)	AN8 ^①

^① ECE R110 approval available.

Female Swivel ISO/BSP Parallel Threads with 30° Cone

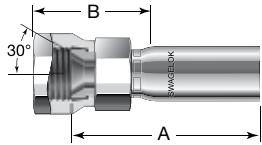

Swivel ISO/BSP Parallel Thread, 30° Cone Size in.	Nominal Hose Size in.	Ordering Number	Dimensions, in. (mm)				End Connection Designator
			A	B	Minimum Inside Diameter	Maximum Outside Dimension	
1/4	1/4	SS-TP4-BS4	2.28 (57.9)	1.53 (38.9)	0.15 (3.8)	0.87 (22.1)	BS4
3/8	3/8	SS-TP6-BS6	2.66 (67.6)	1.69 (42.9)	0.24 (6.1)	1.02 (25.8)	BS6
1/2	1/2	SS-TP8-BS8	2.90 (73.7)	1.81 (46.0)	0.36 (9.1)	1.23 (31.2)	BS8

Dimensions shown with swivel nut pushed toward hex.

Universal Globe Seal, Metric Female Swivel Nut

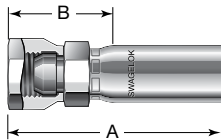

Universal Globe Seal, Metric Female Swivel Nut Size mm	Nominal Hose Size in.	Ordering Number	Dimensions, in. (mm)				End Connection Designator
			A	B	Minimum Inside Diameter	Maximum Outside Dimension	
14	1/4	SS-TP4-MC14	2.38 (60.5)	1.35 (34.3)	0.15 (3.8)	0.87 (22.1)	MC14
18	3/8	SS-TP6-MC18	2.77 (70.4)	1.46 (37.1)	0.24 (6.1)	1.02 (25.8)	MC18
22	1/2	SS-TP8-MC22	3.08 (78.2)	1.51 (38.4)	0.36 (9.1)	0.80 (20.3)	MC22

Dimensions shown with swivel nut pushed toward hex.

7R, 8R, and 7N Series Nylon Hose

Ordering Information

Custom Hose Assemblies

Build a hose assembly ordering number by combining the designators in the sequence shown below.



Typical Ordering Number

1 2 3 4 4 5 6 5 6
SS - 7R 4 TA 4 PM 4 - 28 - F or 71 CM - F
in. cm

1 Material

End Connections

SS = 316 stainless steel

2 Hose

7R = 7R series SAE 100R7 nylon hose
8R = 8R series SAE 100R8 nylon hose
7N = 7N series SAE 100R7
 nonconductive nylon hose

3 Nominal Hose Size, in.

4 = 1/4
 6 = 3/8
 8 = 1/2

4 End Connections

See **End Connection Designator** column in tables on pages 96 to 98.

5 Overall Length

Inches or centimeters, in whole numbers. Include **CM** as shown for centimeter lengths.

6 Options

For multiple options, add designators with a dash between each designator.

F = Fire jacket
F1 = Thermosleeve
N3 = Nitrogen pressure test (7R and 8R Series only)
S = 302 SS spring guard, hose-length
S2 = 302 SS spring guard, 5 in. length (8R sizes only)
T = Lanyard tag
T2 = Two lanyard tags
W = Hydrostatic test
093 = ECE R110 approval, only on 8R hoses with select end connections. See page 110 for additional information.

Mat Tags

MA = Gray **MO** = Orange
MB = Blue **MP** = Purple
MC = Brown **MR** = Red
MG = Green **MW** = White
MK = Black **MY** = Yellow
MN = Pink

Add **2** to the end of the Mat Tag designator for two tags.

Example: MA2

Specify text for tags. See **Hose Tag Text** table, page 109.

See page 107 for detailed descriptions of options.

7P Series—Polyethylene Hose

Features

- Polyethylene hose designed for use in food, dairy, and water applications.
- Smooth-bore polyethylene core.
- Size range of 1/4 to 1/2 in. and working pressures up to 2750 psig (189 bar).
- Internal fiber reinforcement enhances hose pressure rating.
- Smooth, polyurethane blue cover is nonperforated to prevent moisture entrapment and system contamination.
- Polyurethane cover resists abrasion.
- Polyethylene core material is compliant with FDA 21 CFR Part 177.1520 and NSF-51, for use with food, dairy, and water.
- Options include hose covers and spring guards. See page 107 for details.
- For electrical properties, see page 5 for details.

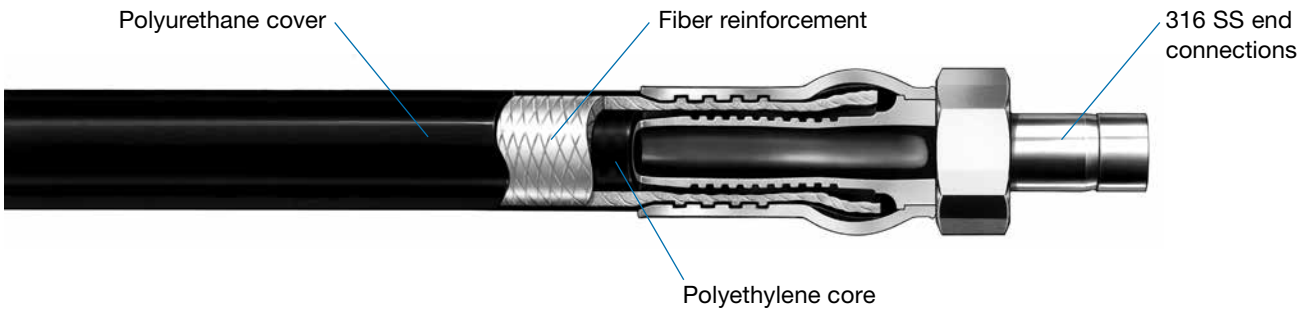

Technical Data

Nominal Hose Size in. (mm)	Inside Diameter in. (mm)	Outside Diameter in. (mm)	Minimum Inside Bend Radius in. (cm)	Temperature Range °F (°C)	Working Pressure at 70°F (20°C) psig (bar)	Minimum Burst Pressure at 70°F (20°C) psig (bar)	Bulk Hose Weight lb/ft (kg/m)
1/4 (6.4)	0.25 (6.4)	0.52 (13.2)	1.25 (3.18)	-10 to 150 (-23 to 65)	2750 (189)	11 000 (757)	0.06 (0.09)
3/8 (9.7)	0.38 (9.7)	0.66 (16.8)	2.00 (5.08)		2250 (155)	9 000 (620)	0.09 (0.13)
1/2 (12.7)	0.50 (12.7)	0.81 (20.6)	3.00 (7.62)		2000 (137)	8 000 (551)	0.12 (0.18)

Cleaning and Packaging

Swagelok polyethylene hose components are cleaned in accordance with Swagelok *Standard Cleaning and Packaging (SC-10)* catalog, [MS-06-62](#). Each hose is bagged individually and boxed; longer hoses are coiled, bagged, and boxed.

Ordering Information and Dimensions

- For custom hose assemblies, see page for 101 for hose sizes, end connections, lengths, and options.

⚠ Caution:
Nonperforated covers may blister in gas service.

7P Series Polyethylene Hose

Ordering Information

Custom Hose Assemblies

Build a hose assembly ordering number by combining the designators in the sequence shown below.



Typical Ordering Number

1 2 3 4 4 5 6 5 6
 SS - 7 P 4 T A 4 P M 4 - 2 8 - F or 7 1 C M - F
in. cm

1 Material

End Connections

SS = 316 stainless steel

2 Hose

7P = 7P series polyethylene hose

3 Nominal Hose Size, in.

4 = 1/4
6 = 3/8
8 = 1/2

4 End Connections

See **End Connection Designator** column in tables on pages 96 to 98.

5 Overall Length

Inches or centimeters, in whole numbers. Include **CM** as shown for centimeter lengths.

6 Options

For multiple options, add designators with a dash between each designator.

F = Fire jacket
F1 = Thermosleeve
S = 302 SS spring guard, hose-length
S2 = 302 SS spring guard, 5 in. length (1/4 and 3/8 in. sizes only)
T = Lanyard tag
T2 = Two lanyard tags
W = Hydrostatic test

Mat Tags

MA = Gray MO = Orange
MB = Blue MP = Purple
MC = Brown MR = Red
MG = Green MW = White
MK = Black MY = Yellow
MN = Pink

Add **2** to the end of the Mat Tag designator for two tags.

Example: MA2

Specify text for tags. See **Hose Tag Text** table, page 109.

See page 107 for detailed descriptions of options.

PB Series Rubber Hose

Features

- Ozone-resistant, general-purpose rubber hose with push-on connections.
- Smooth-bore Buna N core.
- Size range of 1/4 to 1 in. and working pressures up to 350 psig (24.1 bar).
- Internal fiber reinforcement enhances hose pressure rating and ensures connection retention.
- Hose cover resists abrasion.
- Cover is flame-resistant in accordance with 30CFR Part 18.
- Designed for use in general-purpose, compressed air applications and oil transfer.
- Bulk hose and end connections available for field assembly; custom assemblies also available.
- Standard hose color is blue; other hose colors include black, green, gray, red, and yellow.
- Black hose color provides additional UV and ozone resistance due to Neoprene cover.
- Options include tags. See page 107 for details.
- For electrical properties, see page 5 for details.

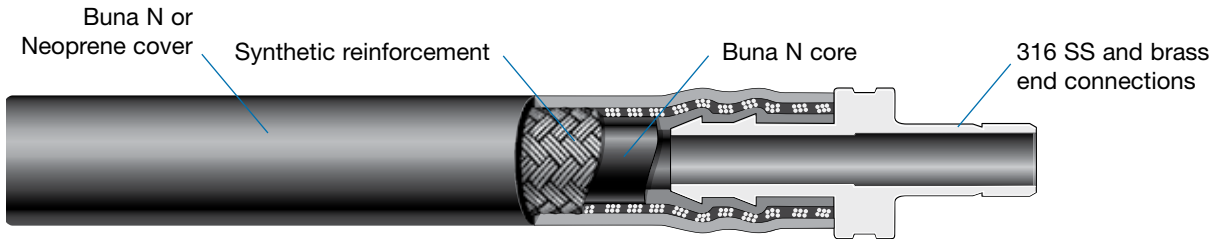

Technical Data

Nominal Hose Size in. (mm)	Inside Diameter in. (mm)	Outside Diameter in. (mm)	Minimum Inside Bend Radius in. (cm)	Temperature Range °F (°C)	Working Pressure at -40 to 70°F (-40 to 20°C) psig (bar)	Minimum Burst Pressure at 70°F (20°C) psig (bar)	Bulk Hose Weight lb/ft (kg/m)
1/4 (6.4)	0.26 (6.6)	0.51 (12.8)	3.00 (7.62)	-40 to 200 (-40 to 93)	350 (24.1)	1400 (96.4)	0.09 (0.13)
3/8 (9.7)	0.39 (9.9)	0.67 (17.0)	3.00 (7.62)		300 (20.6)	1200 (82.6)	0.14 (0.20)
1/2 (12.7)	0.50 (12.7)	0.75 (19.0)	5.00 (12.7)		300 (20.6)	1200 (82.6)	0.14 (0.20)
3/4 (19.0)	0.76 (19.3)	1.07 (27.2)	7.00 (17.8)		300 (20.6)	1200 (82.6)	0.25 (0.37)
1 (25.4)	1.00 (25.4)	1.34 (34.0)	10.00 (25.4)	-20 to 200 (-28 to 93)	300 (20.6) ^①	1200 (82.6)	0.33 (0.49)

① Working pressure of 1 in. PB hose is 300 psig (20.6 bar) from -20 to 70°F (-28 to 20°C)

Pressure-Temperature Ratings

Ratings maintain a minimum factor of 4:1 between working pressure and minimum burst pressure.

Nominal Hose Size, in.	1/4	3/8, 1/2, 3/4	1
Temperature, °F (°C)	Working Pressure, psig (bar)		
-40 (-40)	350 (24.1)	300 (20.6)	—
-20 (-28) to 70 (20)	350 (24.1)	300 (20.6)	300 (20.6)
100 (37)	315 (21.7)	270 (18.6)	270 (18.6)
150 (65)	210 (14.4)	180 (12.4)	180 (12.4)
200 (93)	100 (6.8)	80 (5.5)	80 (5.5)

Cleaning and Packaging

Swagelok PB series rubber hose components are cleaned in accordance with Swagelok *Standard Cleaning and Packaging (SC-10)* catalog, [MS-06-62](#). Each custom hose assembly is bagged individually and boxed; longer hoses are coiled, bagged, and boxed. Bulk rubber hose is packaged and shipped in reels.

⚠ Users must evaluate compatibility in systems containing heated water-based fluids—some conditions may affect the Buna N core.

PB Series Rubber Hose

Ordering Information and Dimensions

- For bulk hose, see below; for end connections for field assembly, see below.
- For custom hose assemblies, see page 106 for hose sizes, end connections, lengths, and options.
- For hose cutters for field assembly, see page 114.
- For a push-on tool for field assembly, see page 114.

Bulk Hose

Bulk hose is available in 250 ft (76 m) reels; the standard color is blue. Select an ordering number from the table below left.

Example: **PB-4**

For hose of a color other than blue, add a hose color designator from the table below right.

Example **PB-4-BK**

Nominal Hose Size in.	Ordering Number
1/4	PB-4
3/8	PB-6
1/2	PB-8
3/4	PB-12
1	PB-16

Rubber Hose Color	Designator
Black	-BK ^①
Gray	-GY
Green	-GR
Red	-RD
Yellow	-YW

^① Black hose made with Neoprene cover. All other colors made with Buna N cover.



Reels contain up to four lengths of hose.

Field Assembly Instructions

1. Cut a clean, square edge on the end of the hose.



2. Cover the first barb of the end connection with the hose.



Note: Lubricating the end connection barbs with a light oil (i.e. 10W40) may ease assembly.

3. Hold the end connection against a flat surface. Grip the hose and push with a steady force until the hose seats flush with the divider tab.



⚠ Do not use a hose clamp.

⚠ Ensure hose is pushed fully until the hose seats flush with the divider tab.

Alternatively, see *Push-On Tool User Manual* [MS-CRD-0190](#), for instructions on using the Push-On Tool to assist in assembly, see page 114.

PB Series Rubber Hose

End Connections

Select a basic ordering number and add **SS** for 316 SS or **B** for brass.

Example: **SS-PB4-SL4**

To determine the cut length of bulk hose for field assembly, subtract dimension B for each end connection from the desired overall length.

Swagelok Tube Fittings

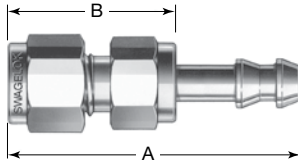

Tube Fitting Size in.	Nominal Hose Size in.	Basic Ordering Number	Dimensions, in. (mm)				End Connection Designator
			A	B	Minimum Inside Diameter	Maximum Outside Dimension	
1/4	1/4	-PB4-SL4	1.82 (46.2)	1.08 (27.4)	0.15 (3.8)	0.65 (16.5)	SL4
3/8	3/8	-PB6-SL6	2.02 (51.3)	1.17 (29.7)	0.26 (6.6)	0.87 (22.1)	SL6
1/2	1/2	-PB8-SL8	2.34 (59.4)	1.31 (33.3)	0.36 (9.1)	1.01 (25.7)	SL8

Swagelok Tube Adapters

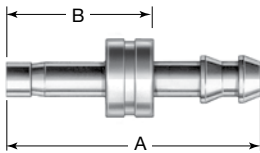

Tube Adapter Size	Nominal Hose Size	Basic Ordering Number	Dimensions				End Connection Designator
			A	B	Minimum Inside Diameter	Maximum Outside Dimension	
Dimensions, in. (mm)							
1/4	1/4	-PB4-TA4	1.77 (45.0)	1.03 (26.2)	0.15 (3.8)	0.54 (13.7)	TA4
3/8	3/8	-PB6-TA6	1.97 (50.0)	1.12 (28.4)	0.23 (5.8)	0.71 (18.0)	TA6
1/2	1/2	-PB8-TA8	2.43 (61.7)	1.40 (35.6)	0.33 (8.4)	0.81 (20.6)	TA8
3/4	3/4	-PB12-TA12	3.14 (79.8)	1.50 (38.1)	0.57 (14.5)	1.08 (27.4)	TA12
1	1	-PB16-TA16	4.11 (104)	1.88 (47.8)	0.79 (20.1)	1.41 (35.8)	TA16
Dimensions, mm (in.)							
6	1/4 in.	-PB4-TM6	45.0 (1.77)	26.2 (1.03)	3.8 (0.15)	13.7 (0.54)	TM6
8	1/4 in.	-PB4-TM8	45.7 (1.80)	26.9 (1.06)	3.8 (0.15)	13.7 (0.54)	TM8
	3/8 in.	-PB6-TM8	49.3 (1.94)	27.7 (1.09)	5.3 (0.21)	18.0 (0.71)	TM8
10	3/8 in.	-PB6-TM10	50.0 (1.97)	28.4 (1.12)	6.6 (0.26)	18.0 (0.71)	TM10
12	1/2 in.	-PB8-TM12	61.7 (2.43)	35.6 (1.40)	8.1 (0.32)	20.6 (0.81)	TM12
18	3/4 in.	-PB12-TM18	79.8 (3.14)	38.1 (1.50)	13.7 (0.54)	27.4 (1.08)	TM18
25	1 in.	-PB16-TM25	104 (4.11)	47.8 (1.88)	19.6 (0.77)	35.8 (1.41)	TM25

PB Series Rubber Hose

Male Pipe Threads,
NPT and ISO/BSP Tapered
(ISO 7)

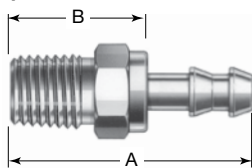

NPT and ISO/BSP Tapered Size in.	Nominal Hose Size in.	Basic Ordering Number	Dimensions, in. (mm)				End Connection Designator
			A	B	Minimum Inside Diameter	Maximum Outside Dimension	
NPT							
1/4	1/4	-PB4-PM4	1.68 (42.7)	0.94 (23.9)	0.15 (3.8)	0.65 (16.5)	PM4
	3/8	-PB6-PM4	1.72 (43.7)	0.98 (24.9)	0.26 (6.6)	0.80 (20.3)	PM4
3/8	3/8	-PB6-PM6	1.82 (46.2)	0.97 (24.6)	0.26 (6.6)	0.87 (22.1)	PM6
1/2	1/2	-PB8-PM8	2.22 (56.4)	1.19 (30.2)	0.36 (9.1)	1.01 (25.7)	PM8
3/4	3/4	-PB12-PM12	2.86 (72.6)	1.22 (31.0)	0.60 (15.2)	1.30 (33.0)	PM12
1	1	-PB16-PM16	3.75 (95.3)	1.52 (38.6)	0.79 (20.1)	1.74 (44.2)	PM16
ISO/BSP Tapered							
1/4	1/4	-PB4-MT4	1.68 (42.7)	0.94 (23.9)	0.15 (3.8)	0.65 (16.5)	MT4
3/8	3/8	-PB6-MT6	1.82 (46.2)	0.97 (24.6)	0.26 (6.6)	0.87 (22.1)	MT6
1/2	1/2	-PB8-MT8	2.22 (56.4)	1.19 (30.2)	0.36 (9.1)	1.01 (25.7)	MT8
3/4	3/4	-PB12-MT12	2.87 (72.9)	1.23 (31.2)	0.60 (15.2)	1.30 (33.0)	MT12
1	1	-PB16-MT16	3.75 (95.2)	1.52 (38.6)	0.79 (20.1)	1.74 (44.2)	MT16

Unions

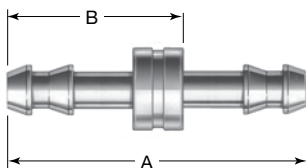

Nominal Hose Size in.	Basic Ordering Number	Dimensions, in. (mm)			
		A	B	Minimum Inside Diameter	Maximum Outside Dimension
1/4	-PB4-6	1.87 (47.5)	1.13 (28.7)	0.15 (3.8)	0.54 (13.7)
3/8	-PB6-6	2.12 (53.8)	1.27 (32.3)	0.26 (6.6)	0.71 (18.0)
1/2	-PB8-6	2.50 (63.5)	1.47 (37.3)	0.36 (9.1)	0.81 (20.6)
3/4	-PB12-6	3.76 (95.5)	2.12 (53.8)	0.60 (15.2)	1.08 (27.4)

PB Series Rubber Hose

Ordering Information

Custom Hose Assemblies

Build a hose assembly ordering number by combining the designators in the sequence shown below.



Typical Ordering Number

1 2 3 4 4 5 6 5 6 7
SS - PB 4 TA 4 PM 4 - 28 - BK or **71 CM - BK - CRN**
in. cm

1 Material

End Connections

SS = 316 stainless steel
B = Brass

2 Hose

PB = PB series rubber hose

3 Nominal Hose Size, in.

4 = 1/4
6 = 3/8
8 = 1/2
12 = 3/4
16 = 1

4 End Connections

See **End Connection Designator** column in tables on pages 104 and 105.

5 Overall Length

Inches or centimeters, in whole numbers. Include **CM** as shown for centimeter lengths.

6 Hose Color

None = Blue, standard hose color
BK = Black
GR = Green
GY = Gray
RD = Red
YW = Yellow

7 Options

For multiple options, add designators with a dash between each designator.

T = Lanyard tag
T2 = Two lanyard tags
W = Hydrostatic test

Mat Tags

MA = Gray	MO = Orange
MB = Blue	MP = Purple
MC = Brown	MR = Red
MG = Green	MW = White
MK = Black	MY = Yellow
MN = Pink	

Add **2** to the end of the Mat Tag designator for two tags.

Example: **MA2**

Specify text for tags. See **Hose Tag Text** table, page 109.

See page 107 for detailed descriptions of options.

Options

Covers

Covers do not change hose technical data.

Fire Jacket (Option F)

- Woven fiberglass coated with specially compounded aerospace-grade orange silicone rubber.
- Resists many hydraulic fluids and lubricating oils.
- Provides insulation from internal system fluid temperature extremes.
- Operating temperature: -65 to 500°F (-53 to 260°C) with short-term flame exposure to 2000°F (1093°C).



Thermosleeve (Option F1)

- Braided fiberglass with saturated synthetic material coating.
- Creates a barrier that prevents direct contact with the hose and resists abrasion.
- Protects hose from weld splatter and resists effects of UV light.
- Operating temperature: up to 1000°F (537°C).



Armor Guard (Option A)

- Interlocking, flexible 302 stainless steel.
- Highly flexible, protects against kinking and abrasion.
- Covers entire length of hose.
- Operating temperature: -325 to 750°F (-200 to 398°C).



Spiral Guard (Options G6, G7, and G8)

- Helical HDPE plastic.
- Highly flexible, protects against abrasion.
- Covers entire length of hose.
- Operating temperature: -180 to 250°F (-117 to 121°C).
- Standard colors are blue, black, and yellow.



316 Stainless Steel Material (Option Z)

- Replaces standard 304 stainless steel overbraid with 316L stainless steel and 300 series stainless steel collar with 316 stainless steel
- Provides greater corrosion resistance.



Spring Guard (Options S, S2, and S7)

- Helical 302 stainless steel.
- Highly flexible, protects against kinking and abrasion.
- Hose-length version covers entire length of hose (option S).
- Five-inch-long version protects each end of hose (option S2).
- Operating temperature: -325 to 850°F (-200 to 454°C).

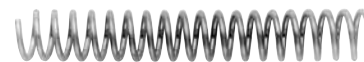

Hose-Length Spring Guard



5 in. Long Spring Guard

Options

Testing

These tests are in addition to or a replacement to the standard testing performed on each hose series.

Helium Leak Testing (Option H7)

- Inboard helium leak tested to a maximum leak rate of 1×10^{-7} std cm³/s.
- Test certification included with order.

Hydrostatic Testing (Option W)

- Hydrostatic pressure test to 1.5 times the rated working pressure of the hose at 70°F (20°C) with no visible leakage for 30 seconds.
- Hose assemblies with tube adapter ends are furnished with nut and preswaged ferrules.
- Test certification included with order.
- Customer-specified testing is available; contact your authorized Swagelok representative.

Nitrogen Pressure Testing (Option N3)

- Nitrogen gas bubble leak test at 200 psig (13.7 bar) with no visible leakage for 5 minutes.
- Hose assemblies with tube adapter ends are furnished with nut and preswaged ferrules.
- Test certification included with order.
- Customer-specified testing is available; contact your authorized Swagelok representative.

Total Organic Carbon Measurement (Option TOC)

Total organic carbon is measured in a gas stream through the product. Results are reported in Toluene equivalent, concentration expressed in ng/dm³. Hydrocarbons can be divided in 2 groups, components with a boiling point below 150°C and components with a boiling point above 150°C. See below specification example:

TOC volatile ≤ 100 ng/dm³ (>150°C)

TOC non-volatile ≤ 10 ng/dm³ (<150°C)

Detection limits of 1 ng/dm³ for each separate category can be reached.

Airborne Particle Count (Option APC)

Airborne particles are measured in a gas stream through the product. Particles are measured with a light scattering laser. Particle sizes possible to be measured range from 0,1µm to 5µm. Sampling volume and limits of particles allowed are derived from ISO 14644-1 cleanroom standard. This standard is written to measure particles in cleanroom air. In this situation the standard is applied on product measurements.

APC conform ISO 14644-1 Class 3 @ 28,3 NI/min

Options

Tags

Lanyard Tag (Option T)

- Stainless steel tag with customer-specified text. See **Hose Tag Text** table for details.
- Attached to the hose with a stainless steel lanyard and aluminum clamp.
- Specify a quantity of 1 or 2.



Clamp Tag (Option T5)

- Stainless steel tag with customer-specified text.
- See **Hose Tag Text** table for details. Limited to 2 lines of text.
- Attached to the hose with two metal bands.



Mat Tag (Option M_)

- Polyester tag with customer-specified text. See **Hose Tag Text** table for details.
- Operating temperature range: -40 to 302°F (-40 to 150°C)
- Attached to the hose with an adhesive.
- Standard colors are black, blue, brown, gray, green, orange, pink, purple, red, white, and yellow.



Key Color	Designator
Gray	MA
Blue	MB
Brown	MC
Green	MG
Black	MK
Pink	MN
Orange	MO
Purple	MP
Red	MR
White	MW
Yellow	MY

Add 2 to the end of the Mat Tag designator for two tags.
Example: MA2

Perma Tag (Option P_)

- Polyester tag encapsulated in platinum-cured silicone with customer-specified text. See **Hose Tag Text** table for details.
- Attached to the hose with an adhesive.
- Designed for sterilization-in-place (SIP), clean-in-place (CIP), and autoclave applications.
- Standard colors are black, blue, brown, gray, green, orange, pink, purple, red, white, and yellow.



Key Color	Designator
Gray	PA
Blue	PB
Brown	PC
Green	PG
Black	PK
Pink	PN
Orange	PO
Purple	PP
Red	PR
White	PW
Yellow	PY

Add 2 to the end of the Perma Tag designator for two tags.
Example: PA2

Hose Tag Text

Specify up to 5 lines of text with 25 characters per line including spaces and commas.

Exception: Clamp tag is limited to 2 lines of text.

Line Number	For Example
1.	Ordering number
2.	Process line
3.	Location
4.	Supplier phone number
5.	Date of manufacture

Options

Approvals

Alternative Fuels-Type Approval (Option 093)

Select FJ series hose assemblies, T series hose assemblies, and 8R series hose assemblies are available tested, tagged, and approved to ECE R110. See the table for the nominal sizes and end connections available.

FJ Series Hose Assemblies:

- Operating temperature –260 to 221°F (–162 to 105°C)
- Maximum working pressure 750 psig (51.7 bar); pressure classification 5.

T Series Carbon Black-Filled PTFE Hose Assemblies:

- Operating temperature –40 to 248°F (–40 to 120°C)
- Maximum working pressure 435 psig (30 bar); pressure classification 1.

8R Series Hose Assemblies:

- Operating temperature –40 to 185°F (–40 to 85°C)
- Maximum working pressure 3770 psig (260 bar); pressure classification 0.

Processing

Cleaning to CGA 4.1 (Option G):

- Hose wetted surfaces are cleaned to CGA 4.1 for use in non-oxygen enriched applications.

Cleaning to ASTM G93, Level C (Option C):

- Clean hose assembly wetted surfaces to ASTM G93 level C.

Oxygen Service Hazards

For more information about hazards and risks of oxygen-enriched systems, refer to *Oxygen System Safety* technical report, [MS-06-13](#).

Options

Availability

Availability of options by hose series is shown below, but may be limited by hose size.

Applications, hose operating parameters, and hose length must be considered when selecting options.

Options		Hose Series																							
		FX	FM	FJ	FL	AH	FV	FN	FZ	T	B	X	S	C	J	N	W	F	U	NG	7R	8R	7N	7P	PB
Covers	Y Insulation	✓	✓	✓	✓	✓				✓	○	✓	○	✓	✓	✓	✓	✓	✓						
	Fire jacket	✓	✓	✓	✓	✓				✓	✓	✓	✓	✓	✓	✓	✓	✓	✓	✓	✓	✓	✓	✓	✓
	Thermosleeve	✓	✓	✓	✓	✓				✓										✓	✓	✓	✓	✓	
	Armor guard	✓		✓		✓						✓	✓	✓	✓	✓	✓	✓	✓						
	Spiral guard											✓	○	✓	✓	✓	✓	✓	✓						
	Spring guard— Hose length		○							✓												✓	✓	✓	✓
	Spring guard— 5 in. long																			Std			○		○
	316L SS braid	✓	Std	✓		Std				○															
Testing	Helium leak testing	✓	✓	✓	✓	✓		✓	✓																
	Hydrostatic testing		✓	✓	✓	✓				✓	✓	✓	✓	✓	✓	✓	✓	✓	✓	✓	✓	✓	✓	✓	✓
	Nitrogen pressure testing	✓	✓	✓	✓	✓				✓										✓	✓	✓			
Tags	Lanyard tag	✓	✓	✓	✓	✓	✓	✓	✓	✓	✓	✓	✓	✓	✓	✓	✓	✓	✓		✓	✓	✓	✓	✓
	Two lanyard tags	✓	✓	✓	✓	✓	✓	✓	✓	✓	✓	✓	✓	✓	✓	✓	✓	✓	✓		✓	✓	✓	✓	✓
	Clamp tag	✓	✓	✓		✓				✓	✓	✓		✓											
	Mat tag	✓	✓	✓	✓	✓				✓	✓	✓	✓	✓	✓	✓	✓	✓	✓	○	✓	✓	✓	✓	✓
	Perma tag												○		✓		✓		✓						
Approval	Alternative fuels-type ECE R110			○					○														○		
Processing	Cleaning to CGA 4.1	✓		✓	○	✓		✓	✓																
	Cleaning to ASTM G93, Level C	✓	✓	✓	✓	✓		✓	✓	✓	✓	✓	✓	✓	✓	✓	✓	✓	✓						
Hose Core		Metal								Fluoropolymer								Nylon				Polyethylene	Rubber		

✓ Available in all sizes.

○ Configurations may affect availability.

Options

Considerations for Insulated Hoses

Free Air Convection

Hoses that transfer cold or hot fluids can impact the temperature of other nearby fluid systems. When cold hoses are routed too close to each other, the surface temperature of the hoses can fall below the dew point, causing condensation to form. When hot hoses are routed too close to each other, hot spots can develop that are above allowable temperature parameters.

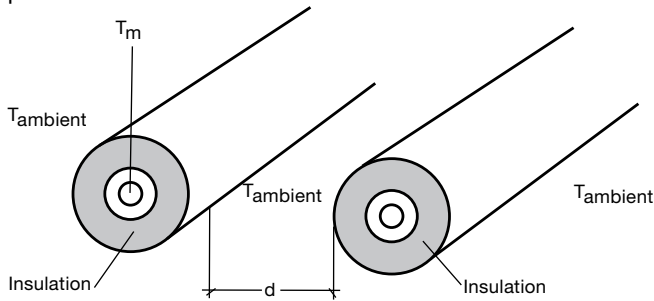

The smaller the distance (d) between the hoses, the closer the air temperature ($T_{ambient}$) between the hoses will be to the media temperature (T_m) in the hose. A general recommendation is to keep wrapped insulated hoses (Y insulation option) at least 12 in. (31 cm) apart. If hoses are spaced closer than this, consider using additional layers of insulation.

Air Flow

Stagnant air creates an undesirable scenario for the surface temperature of the hose due to the decrease in heat transfer coefficient. As air flow increases, surface temperatures will trend more towards the ambient environment temperature.

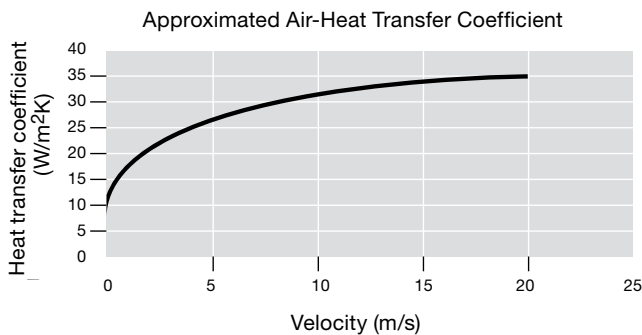

One worst-case example is when a hose is routed through a confined area, such as a subfloor. In the case of cold media flowing through the hose, this could cause condensation to form on the outside of the hose which may drip onto sensitive electronics.

Humidity and Dew Point

Dew point can be approximated using the formula:

$$T_d = T - [(100 - RH)/5]$$

where T_d is the dew point temperature (in degrees Celsius), T is the ambient air temperature (in degrees Celsius), and RH is the relative humidity (in percent).

When selecting the number of layers of insulation to prevent condensation in an application, use the highest expected humidity that the hose will experience.

Energy Savings

Uninsulated hoses are a constant source of wasted energy. Insulation can typically reduce energy losses by up to 90% and help ensure proper and consistent temperature of plant equipment. Other reasons to insulate these hoses include:

- To facilitate proper temperature control to a process, such as steam or coolant lines.
- To protect the environment and reduce the amount of energy used for heating purposes, resulting in lower emissions.
- To control surface temperatures for personnel protection and safety.

Safe-to-Touch Recommendations

ASTM C1055 (Standard Guide for Heated System Surface Conditions that Produce Contact Burn Injuries) recommends that surface temperatures remain at or below 60°C (140°F), as the average person can touch a 60°C (140°F) surface for up to five seconds without sustaining irreversible burn damage. Choosing the proper thickness of insulation can lower the external temperature to reduce the chance of a burn injury.

Bending a Wrap-Insulated Hose (Y insulation option)

Hose technical data, including minimum bend radius, does not change when insulating a hose. However, bending the hose may affect the insulation properties. To minimize these effects, employ bends with a larger bend radius. If this is not possible, consider using additional layers of insulation.

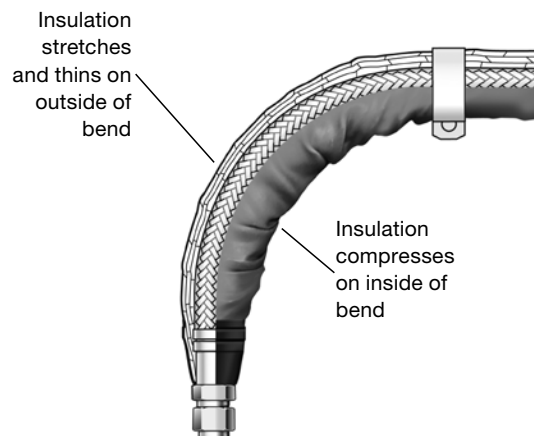

Options

Y Insulation Option

Features

- Rated for continuous hose surface temperature use from -53°C (-65°F) up to 125°C (257°F).
- Low thermal conductivity aerogel insulation material minimizes the bulk needed to achieve desired surface temperatures.
- Flexible polyolefin heat shrink cover enables the product to be flexible, vapor permeation resistant, and abrasion resistant
- Silicone boots at hose ends protect the insulation

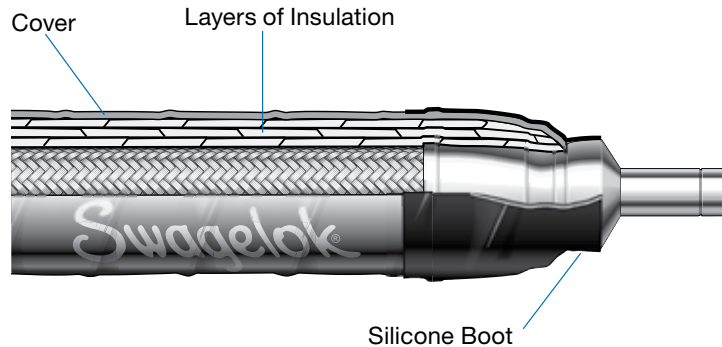

Suffix Code Structure



Example hose assembly part number:
SS-FJ8TA8TA8-55-YB4

1 Insulation Designator

Y = Insulation Option (hose size 1/4 in. and larger)

2 Cover Color

Standard

- B = Blue
- R = Red

Optional

- K = Black
- W = White

3 Layers of Insulation

Nominal Radial Thickness

- 2 = 0.21 in. (5.4 mm)
- 3 = 0.30 in. (7.7 mm)
- 4 = 0.39 in. (10.0 mm)
- 5 = 0.48 in. (12.3 mm)

Nominal Radial Thickness of Insulation

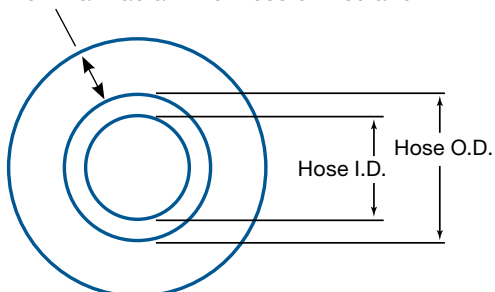

For more information, contact your authorized Swagelok sales and service representative.

swagelok.com

Hose Surface versus Media Temperature on 1/2 in. X Series hose

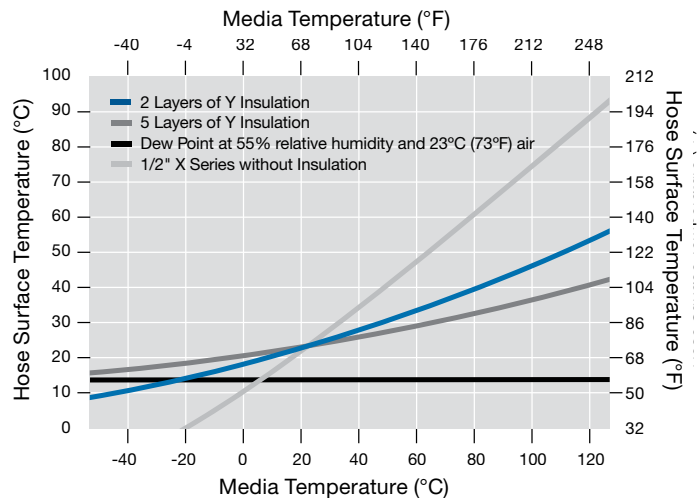

Test conditions for example plots:

- Environment temperature: 23°C (73°F)
- Air flow: Isolated in a chamber with no air flow
- Media Pressure: 6 to 10 psi (0.41 to 0.68 bar)
- Media Flow Rate: 22 to 26 l/min
- Media type: Liquid
- Free air around hose: 6 in (15.2 cm)

Tools and Accessories

Assembly Tools for Nylon, Polyethylene, and Rubber Hose

Push-On Tool

Portable, manually operated tool for inserting end connections into nylon, polyethylene, and rubber hose.



- Inserts end connections into 1/4 to 1 in. hose.
- Bench mounting required.
- 10 in. (25 cm) H, 14 in. (36 cm) W, 28 in. (71 cm) D; 35 lb (15.9 kg).

Ordering number: **MS-SPOT**

Refer to Swagelok *Push-On Tool User's Manual*, [MS-CRD-0190](#), for additional information.

Cutting Tool for Hose and Soft Tubing

Use to cut nylon, polyethylene, or rubber hose, as well as vinyl or PFA tubing to the desired length for field assembly.



- Cuts hose and tubing up to 1 in. nominal size.

Ordering number: **MS-HC-SC-1A**

See SAE J1273, *Recommended Practices for Hydraulic Hose Assemblies*, for information on installation and use of hose.

www.sae.org

Safe Product Selection

When selecting a product, the total system design must be considered to ensure safe, trouble-free performance. Function, material compatibility, adequate ratings, proper installation, operation, and maintenance are the responsibilities of the system designer and user.

⚠ WARNING

Do not mix/interchange Swagelok products or components not governed by industrial design standards, including Swagelok tube fitting end connections, with those of other manufacturers.

Warranty Information

Swagelok products are backed by The Swagelok Limited Lifetime Warranty. For a copy, visit swagelok.com or contact your authorized Swagelok representative.

Swagelok, Ultra-Torr, VCO, VCR— TM Swagelok Company
© 2009–2024 Swagelok Company
MS-01-180, RevAE, October 2024